

BIXOLON®

Network Connection Manual

SRP-S320

LINERLESS PRINTER

Ver. 1.01

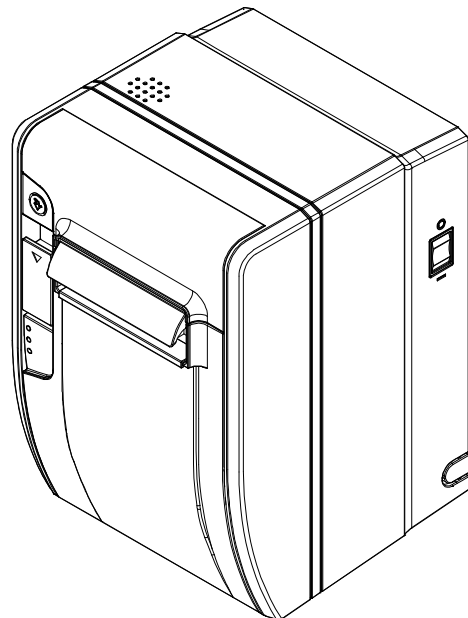
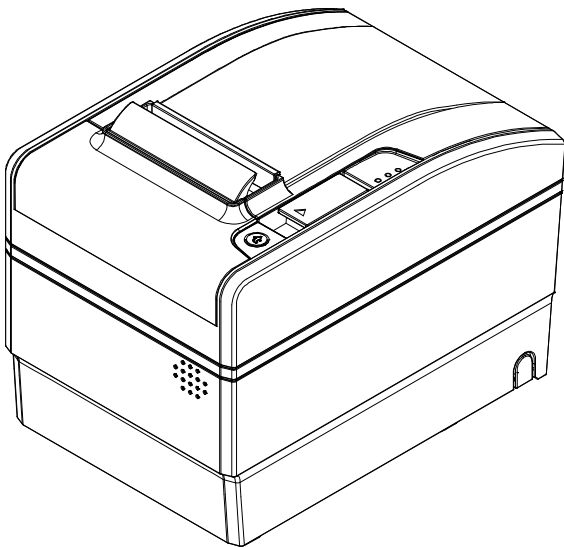

<http://www.bixolon.com>

Table of Contents

1. Manual Information	3
2. Precautions	3
3. Specifications	4
4. How to Connect	5
4-1 Connecting Printer	5
4-1-1 USB cable.....	5
4-1-2 WLAN	5
4-2 Checking Network Setting	6
4-2-1 LAN and Wireless(WLAN or BLUETOOTH)	6
4-2-2 LAN Setting Values.....	7
4-2-3 WLAN Setting Values	8
4-3 Android Soft AP mode	9
4-4 iOS Soft AP mode.....	10
4-5 How to change Infrastructure mode.....	11
5. Ethernet Test by using Windows Test Page	13
6. Factory Reset	20
6-1 Initializing WLAN Setting	20
6-2 Factory Reset Values	21
7. Troubleshooting	22

1. Manual Information

This manual provides information on the connection of wireless network with the printer.

This document contains proprietary information of BIXOLON and its affiliates.

You may utilize the information solely for the purpose of facilitating authorized sales and service of, or developing software and similar products for authorized use with, BIXOLON products, provided that such proprietary information may not be used, reproduced, or dis-closed to any other parties for any other purpose without the prior written permission of BIXOLON.

BIXOLON has no liability for loss or damage arising from or relating to your use of the information in the document.

© BIXOLON Co., Ltd. All rights reserved.

We at BIXOLON maintain ongoing efforts to enhance and upgrade the functions and quality of all our products. In following, product specifications and/or user manual content may be changed without prior notice.

2. Precautions

- The printer has to be within 100m(Outdoor) from AP(Access point) to connect WLAN. Although 35m is able to communicate in door, WLAN could be affected by environment to be shorten.
- The maximum separating distance may be shortened if transmission obstacles, such as cement walls, are present.
- If a device (such as a microwave oven, wireless LAN, etc.) that uses the same frequency is present, transmission may be interrupted. Separate the printer and Bluetooth-enabled device from such interrupting devices by a distance of at least 5m.

3. Specifications

CATEGORIES	FEATURE	IMPLEMENTATION	
LAN Specification	Interface	10/100 Base-T All in one(Auto detection)	
	Protocol	DHCP Client, HTTP, ARP, ICMP, IPv4, TCP, UDP	
WLAN Specification	Operation Mode	Infrastructure, Soft AP, Ad-hoc, Wi-Fi Direct	
	Wireless Standard	IEEE 802.11b/g/n, IEEE 802.11a/b/g/n	
	Range	Up to 100m free space (Outdoor)	
	Security		WEP64/128
			WPA1/2 – PSK
			WPA 1/2 – Enterprise (EAP-TLS, EAP-TTLS, PEAP, LEAP, EAP-FAST)
Management		WLAN Configuration tool, HTTP, Smart connection APP	

4. How to Connect

WLAN can be configured through the printer's WLAN interface. Likewise, WLAN can also be configured through the printer's USB interface.

4-1 Connecting Printer

4-1-1 USB cable

Connect USB cable to Printer, PC device.
Use the "Net Configuration Tool" to adjust the settings.

4-1-2 WLAN

Connect to the AP (Access Point) configured in Infrastructure mode in order to connect to the LAN/wireless network

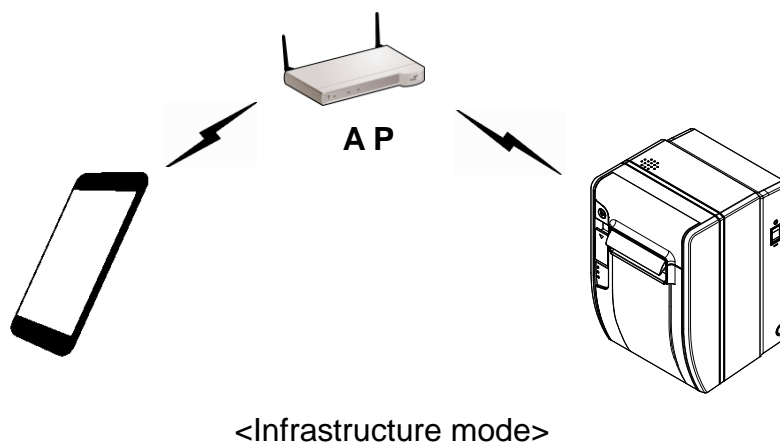

In order to configure the network between the wireless host device and the printer, set the printer to Soft AP Mode.

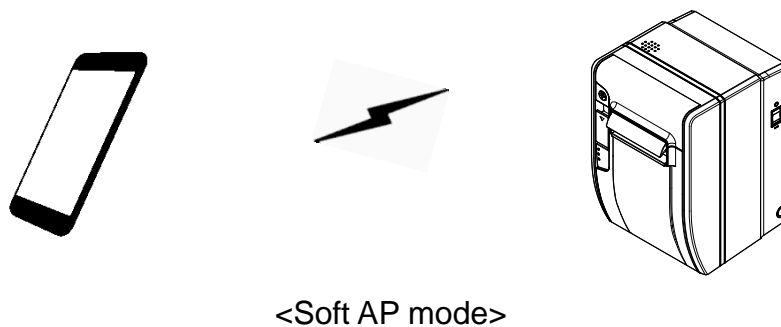

* Soft AP mode is only supported on WLAN.

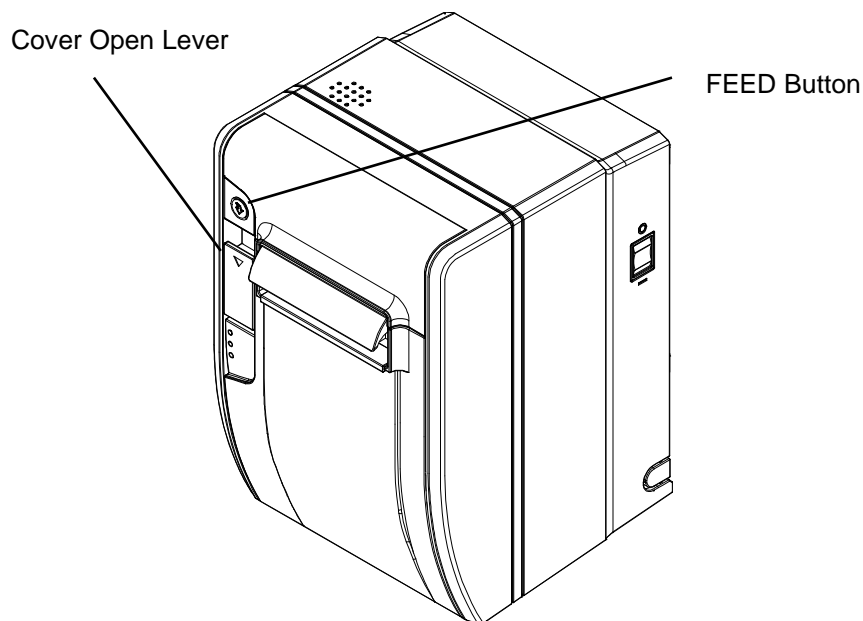
4-2 Checking Network Setting**4-2-1 LAN and Wireless(WLAN)**

After the printer has finished booting, open the printer cover and press and hold the FEED Button. This will cause the interface setting confirmation mode.

Then add the paper, close the cover, and check that the following message is printed.

* Errors LED is toggled/blinked until WLAN is booted

Checking Interface Setting

- 0: Exit
- 1: LAN Information Print
- 2: LAN Factory Reset and Reboot Printer
- 3: WLAN Information Print
- 4: WLAN Factory Reset and Reboot Printer
- 5 or more: None

Select Modes by Feed button control as below.

- Step 1. Short-press as many times as
The mode number to choose.
- Step 2. Long-press over 1 second.

*e.g. To choose Mode 2, press Feed
Button 3 times(short-short-long)

If the above message is printed, select Mode 1, and you will see the following LAN data.
(To select Mode 1, press the Feed button once quickly/ once long.)

4-2-2 LAN Setting Values

Classification	Item	Description	Input Range
Network	Inactivity Time	TCP connection hold time	0~3600 integer
	IP Assignment Method	IP Assignment Method	DHCP/Manual
	IP Address	Printer IP	IP Address
	Subnet Mask	Subnet mask	IP Address
	Gateway	Default Gateway	IP Address

4-2-3 WLAN Setting Values

Classification	Item	Description	Input Range
Home		WLAN setting status display	
Network	Network Mode	Wireless LAN operating mode	Infrastructure/Adhoc
	Adhoc Channel	Channel when creating Adhoc network	1~14
	SSID	ID of the AP to connect	1~32 letters
	Inactivity Time	TCP connection hold time	0~3600 integer
	IP Assignment Method	IP Assignment Method	DHCP/Manual
	IP Address	Printer IP	IP Address
	Subnet Mask	Subnet mask	IP Address
	Gateway	Default Gateway	IP Address
	DNS	Domain name server IP	IP Address
Authentication	Authentication	Wireless LAN authentication method	open, shared, wpa1/2-psk, wpa1/2
	Cryptograph	Wireless LAN encryption method	none, WEP64/128, TKIP, AES
	EAP Mode	Authentication method	none, PEAP, TLS, LEAP, FAST
	WEP Key	Key for WEP encryption method	WEP64 (5 Ascii, 10 Hex) WEP128 (13 Ascii, 26 Hex)
	PSK Key	Key for PSK encryption method	1~64 letters
	Authentication ID	ID for EAP Authentication	1~32 letters
	Authentication PW	Password for EAP Authentication	1~32 letters



Note

For changing network setting values using Net configuration tool, Refer to 'Net configuration tool manual'.

4-3 Android Soft AP mode

1) Select "Wi-Fi".

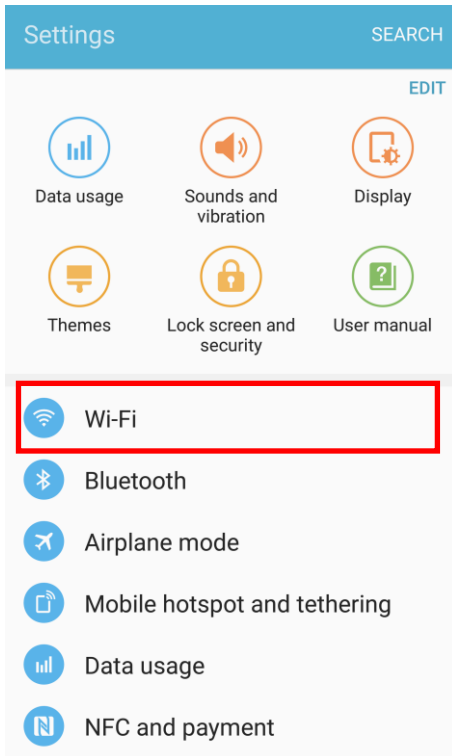

2) Select the printer to connect.



3) Select "CONNECT".

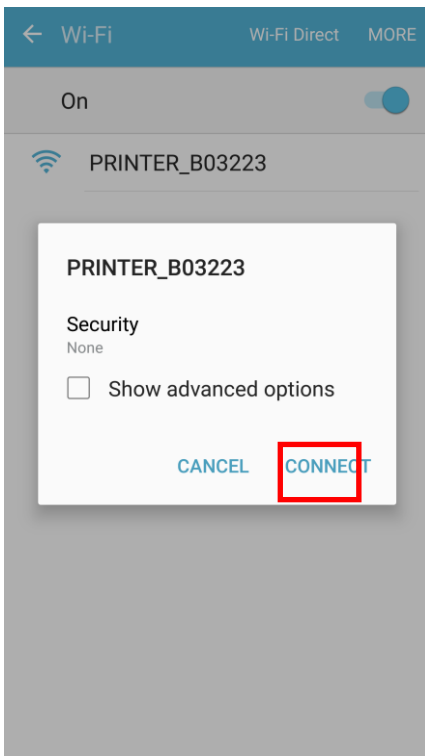

4) Wi-Fi communication is available.

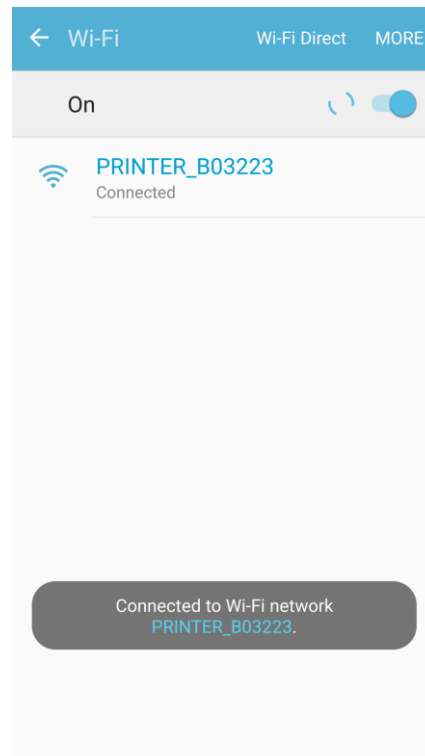

4-4 iOS Soft AP mode

1) Select "Wi-Fi".

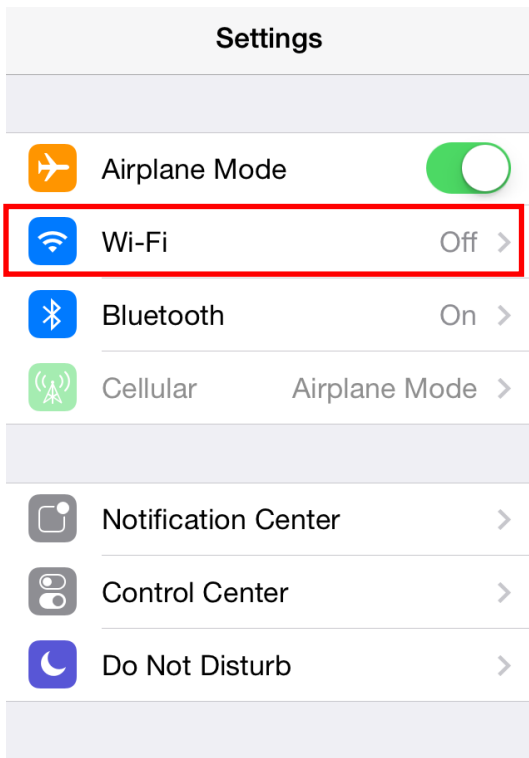

2) Wi-Fi ON and Select the printer to connect.

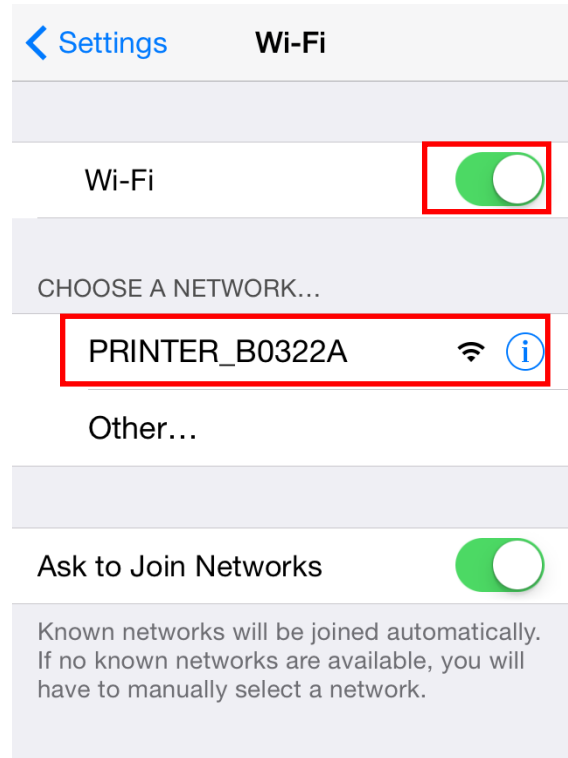

3) Wi-Fi communication is available.

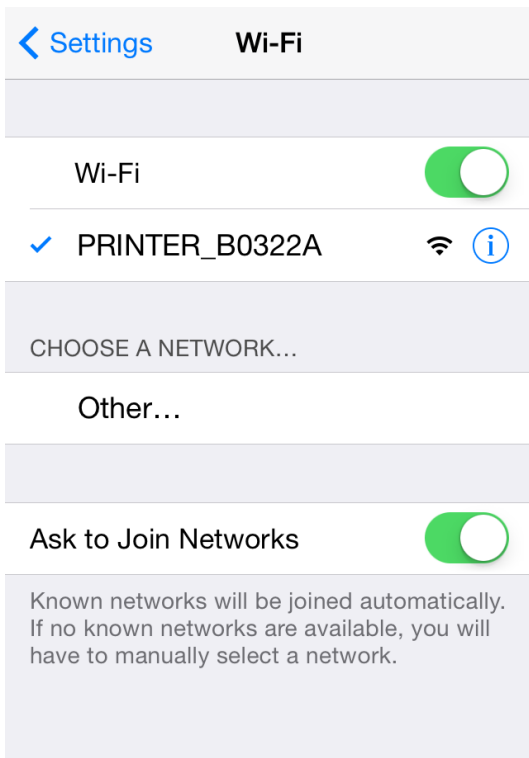

4-5 How to change Infrastructure mode

- 1) Enter the IP address of the printer in the address bar, and the following login window will pop up. Enter the ID and Password set for the printer, and then click [LOG IN]
(Default User Name: admin, Password: password)

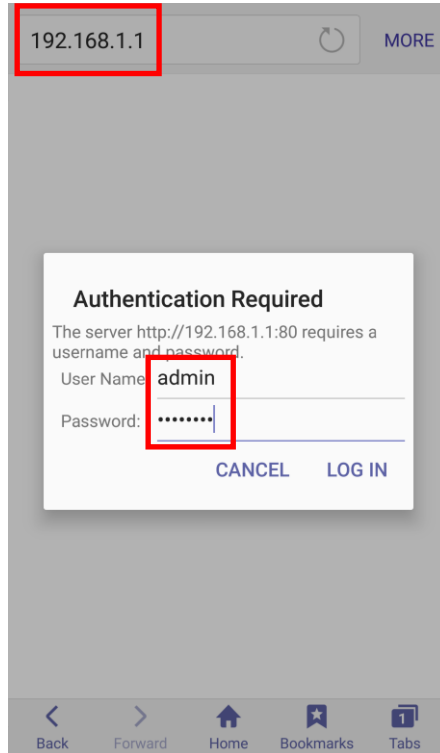

- 2) Select “Wireless” to change Wi-Fi mode.

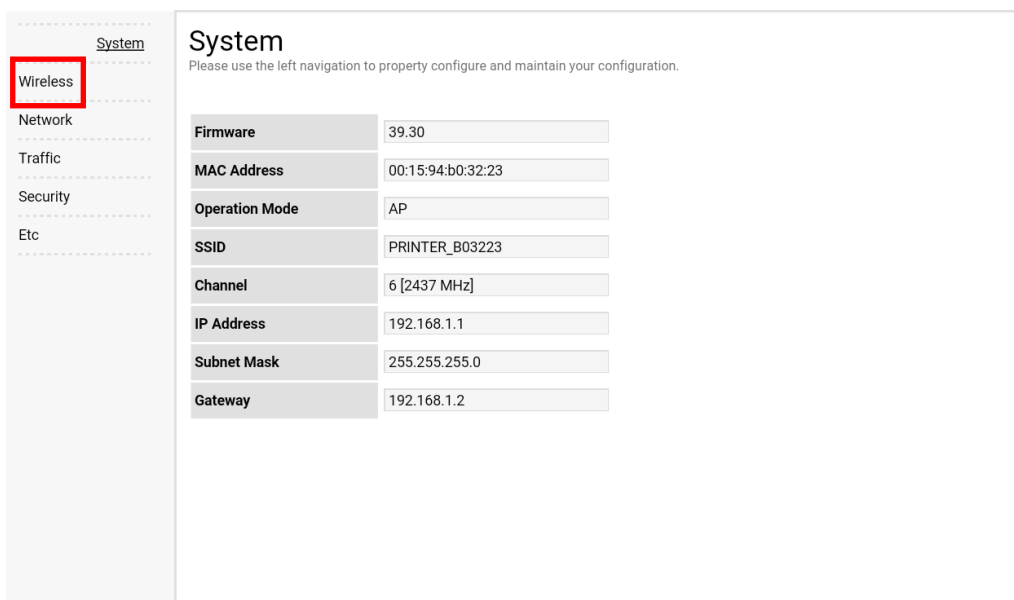

3) Select “Infrastructure”, and set SSID, WLAN Security Type.

The screenshot displays the 'Wireless' configuration page. On the left is a navigation menu with 'Wireless' selected. The main content area is titled 'Wireless' and includes a sub-header: 'Please use the left navigation to properly configure and maintain your configuration.' Below this, there are three configuration fields: 'Connection Type' with a dropdown menu showing 'Infrastructure', 'SSID' with a text input field containing 'TEST_AP', and 'WLAN Security Type' with a dropdown menu showing 'Open'. To the right of the 'WLAN Security Type' dropdown is an unchecked checkbox labeled 'Enterprise'. A warning message states: 'If you try connect, this connection will be disconnected.' At the bottom right, there is a 'Save' button. A red rectangular box highlights the 'Connection Type' and 'WLAN Security Type' dropdown menus.

4) Reboot the Printer.

5. Ethernet Test by using Windows Test Page

You can use the Windows printer driver as shown below when there is no test program. Operating systems that allow you to use the Windows printer driver are Windows, XP, Server 2003, VISTA, 2008 Server, 7, 8, 10.



Note

You can download the latest version of Windows driver from our home page. (www.bixolon.com)

- 1) Double-click the Windows Driver installation file.
- 2) Click **Install**.

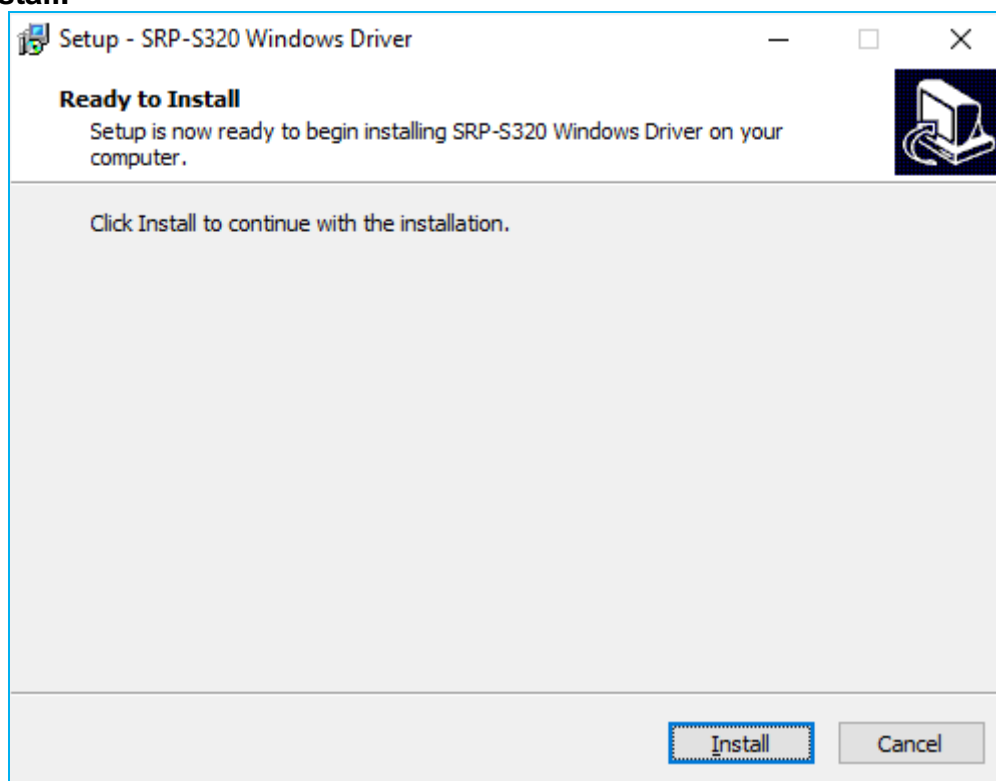

3) Select **Installation** and click **Next**..

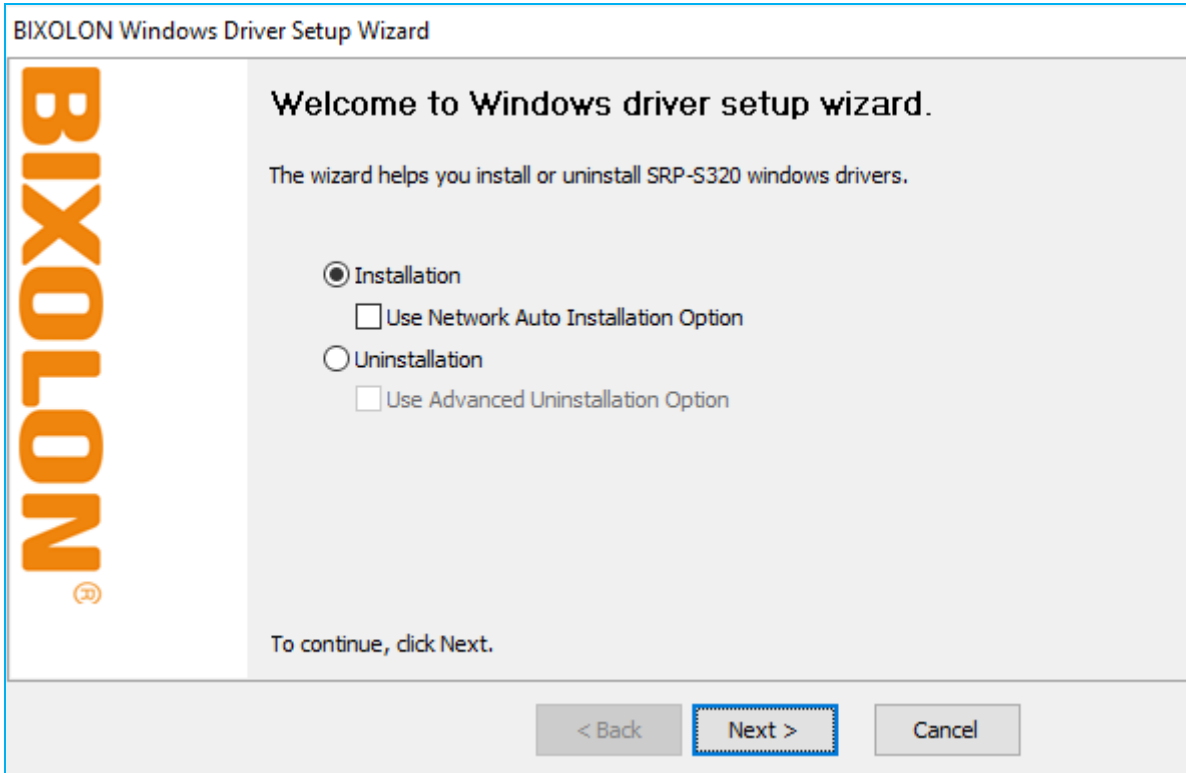

4) Select **Model Name** and click **Next**.

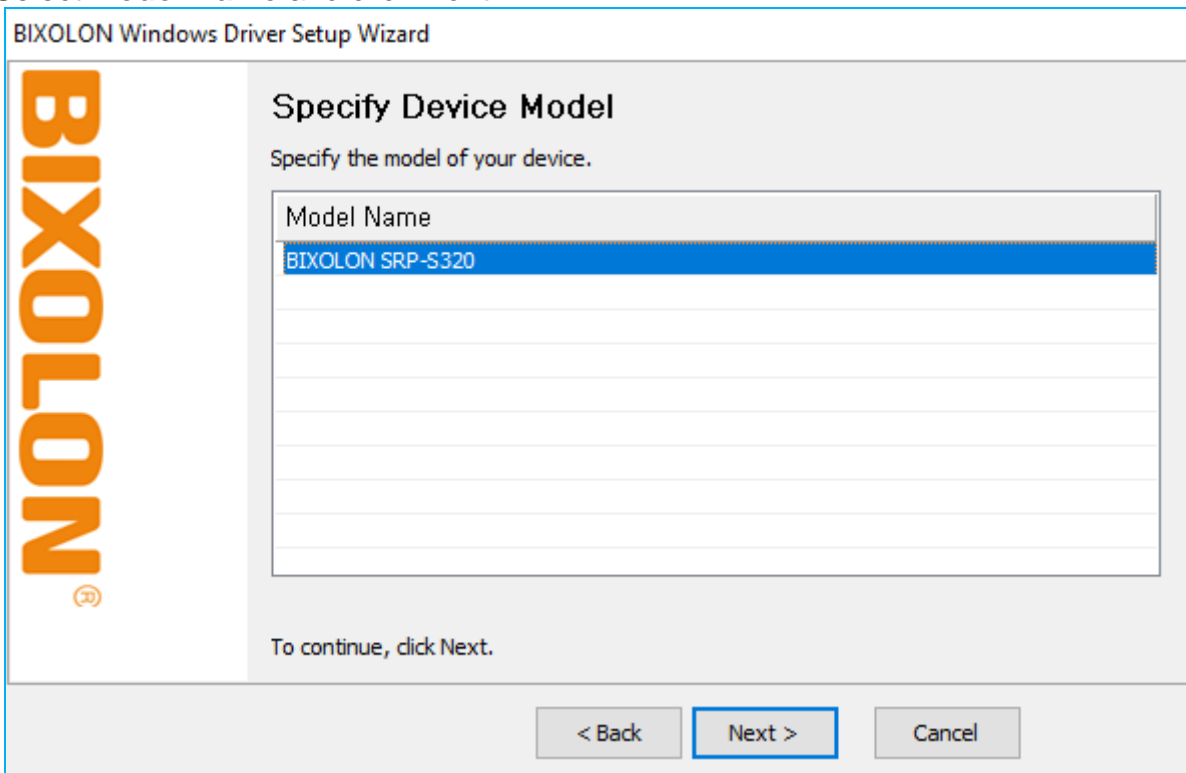

5) Select **Ethernet** and click **Add TCP/IP Port**.

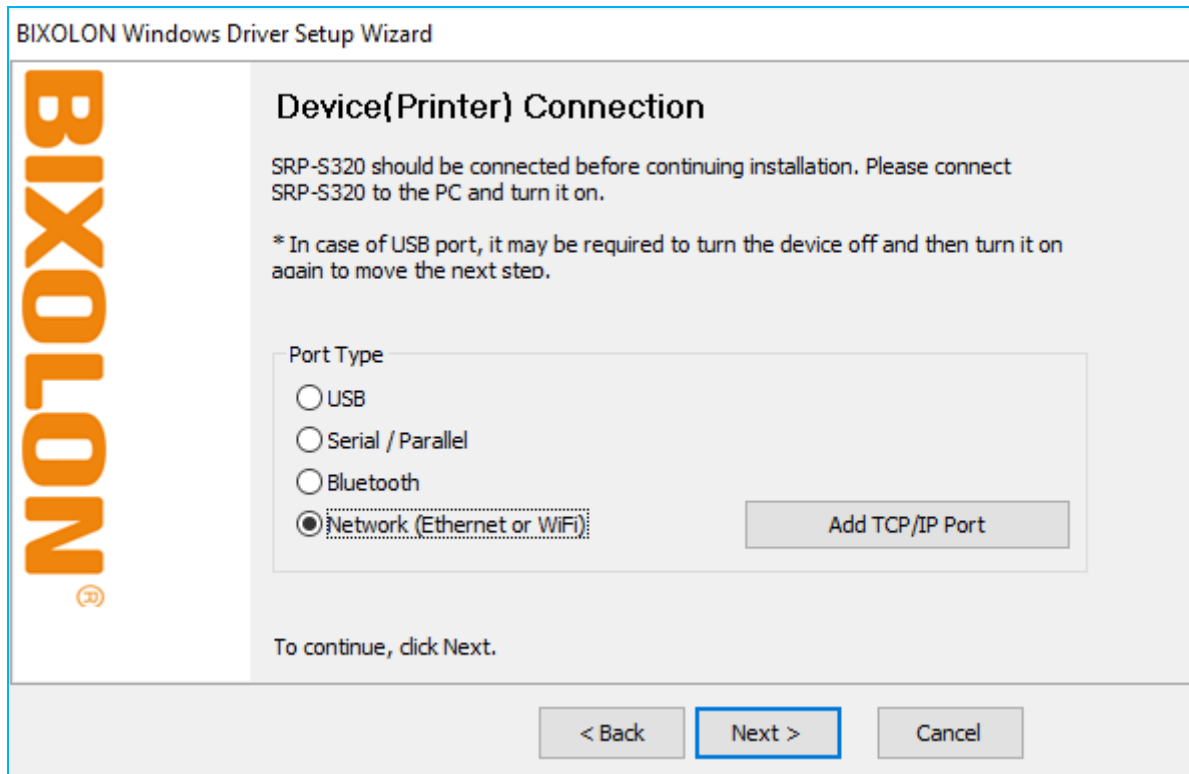

6) Enter the IP address and port number, and then click **Next**.

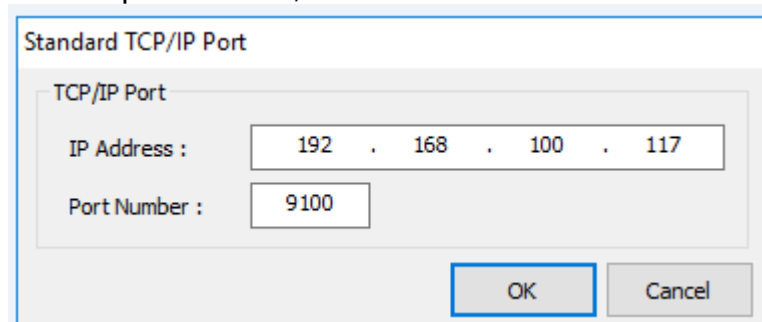

7) Click **Next**.

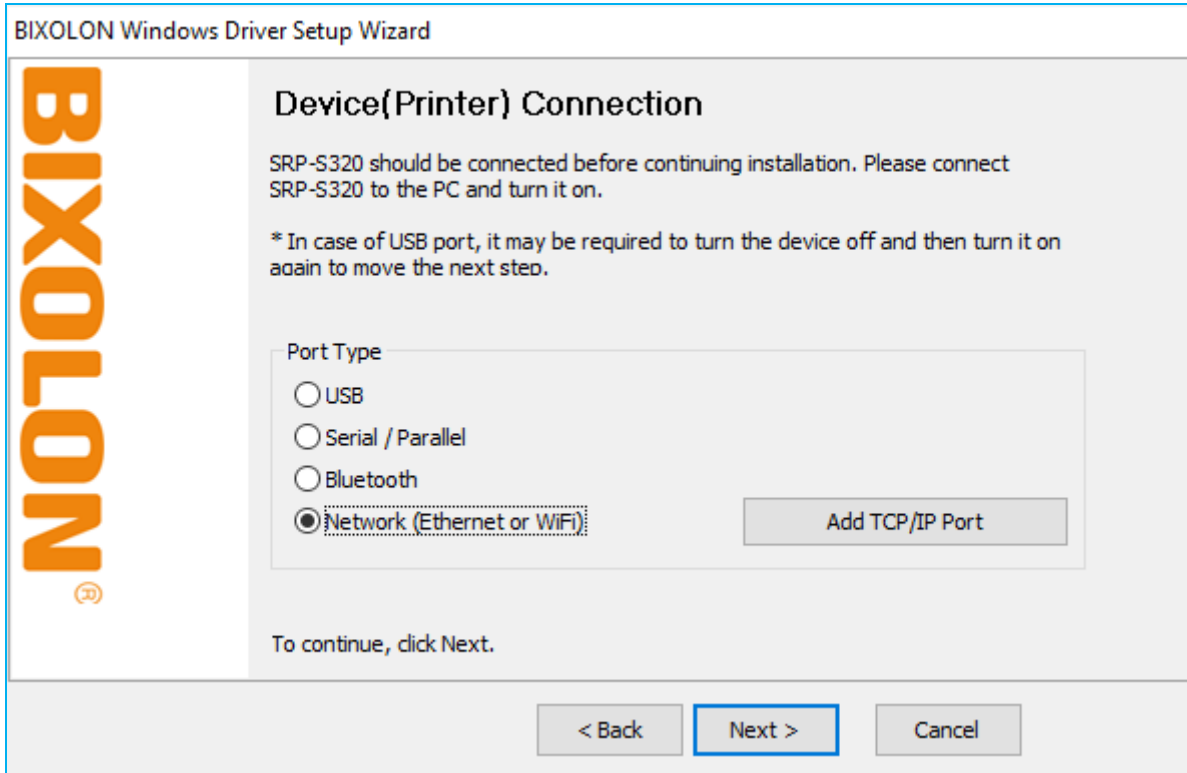

8) Click **Next**.

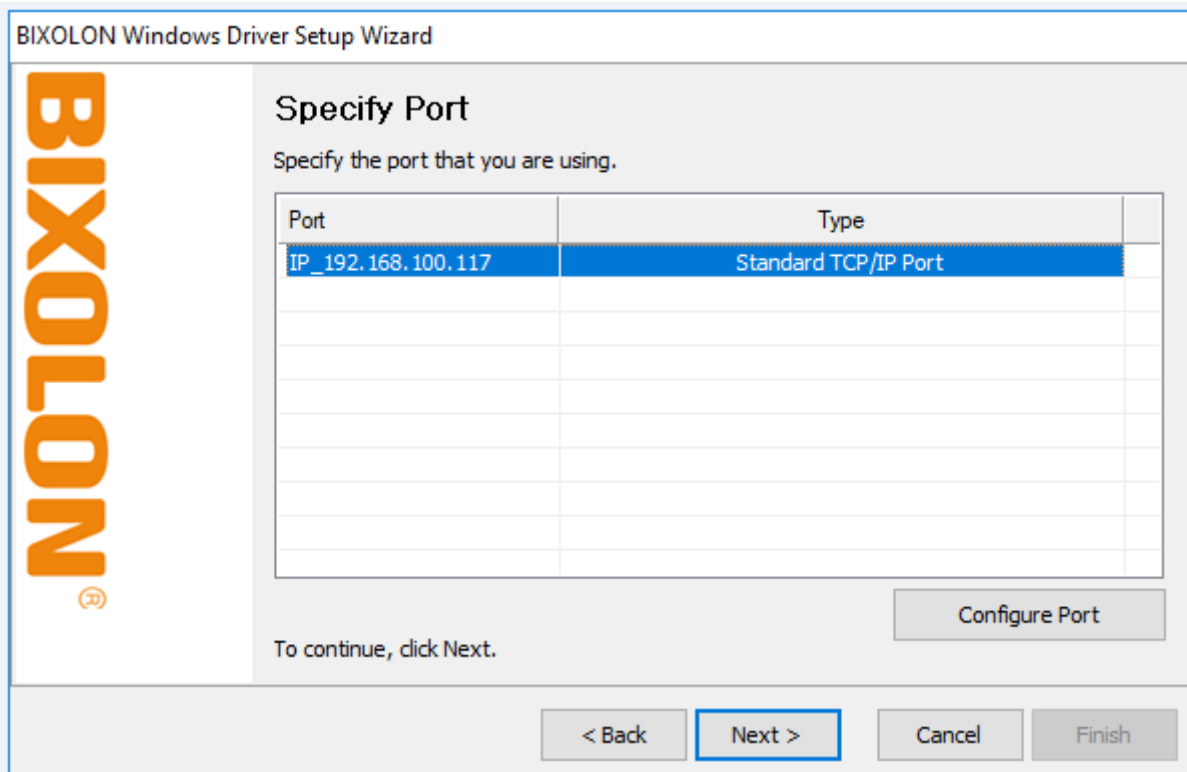

9) Click **Next**.

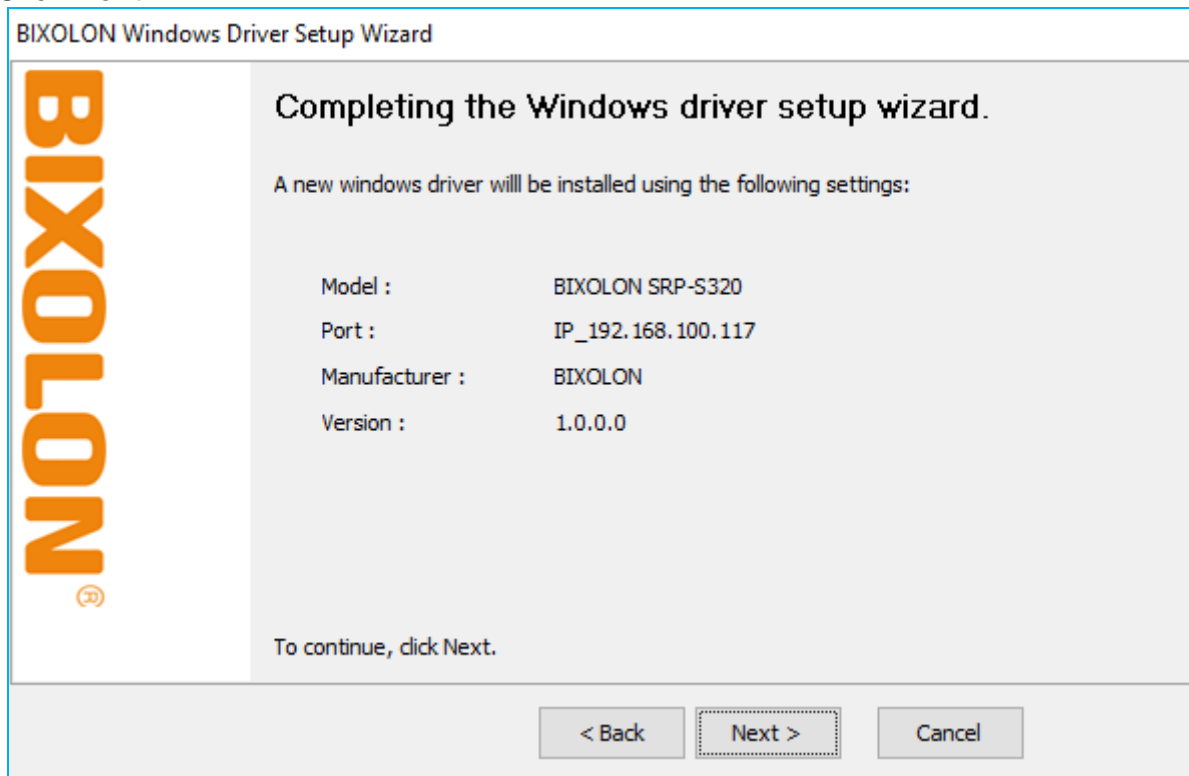

10) Click **Finish**.

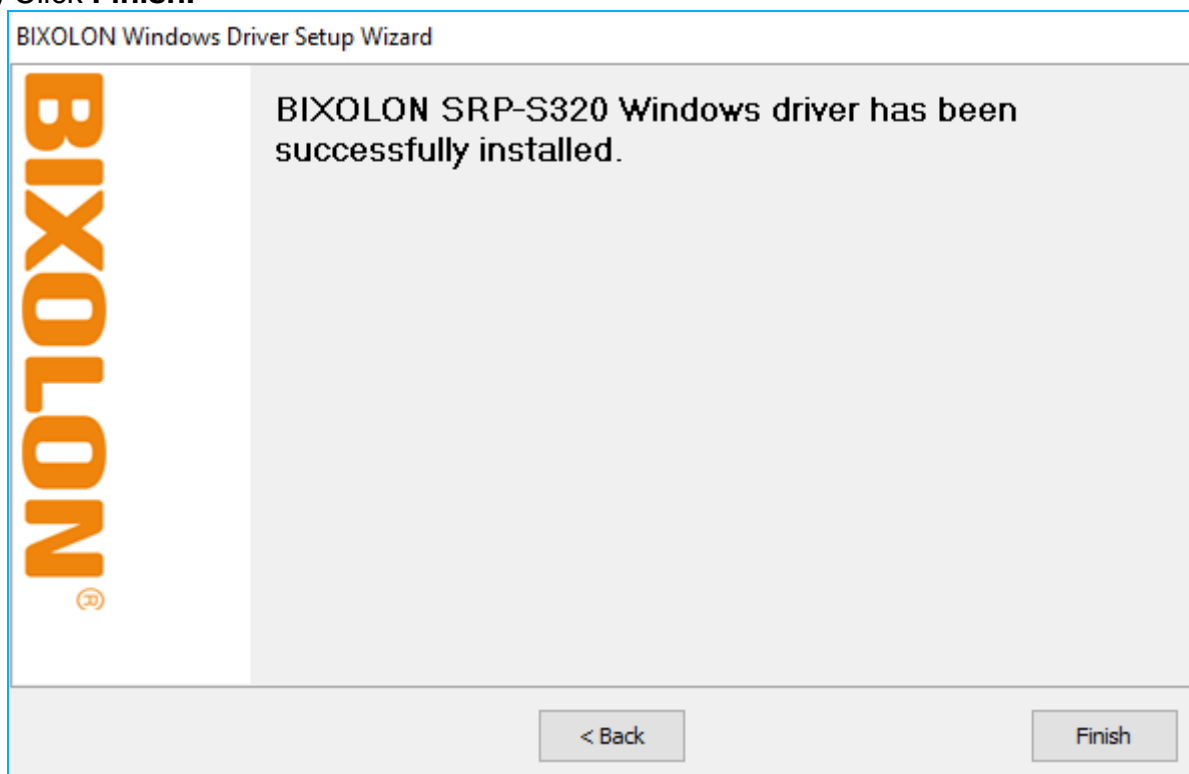

11) Open the printer properties window in the Windows OS.

(1) Installing on Windows XP / Server 2003

※ Control Panel – Printers and Faxes.

(2) Installing on Windows VISTA / Server 2008 / 7 / 8 / Server 2012 / 10

※ Control Panel – Hardware and Sound – Device and Printers.

12) In the **Ports** tab, click **Configure Port**.

13) Match the communication settings to those of the printer.

Configure Standard TCP/IP Port Monitor

Port Settings

Port Name: IP_192.168.100.117

Printer Name or IP Address: 192.168.100.117

Protocol

Raw LPR

Raw Settings

Port Number: 9100

LPR Settings

Queue Name:

LPR Byte Counting Enabled

SNMP Status Enabled

Community Name: public

SNMP Device Index: 1

OK Cancel

- 14) Click **Print Test Page** and check printing status. Proper installation of the driver is indicated if the test page is printed normally.

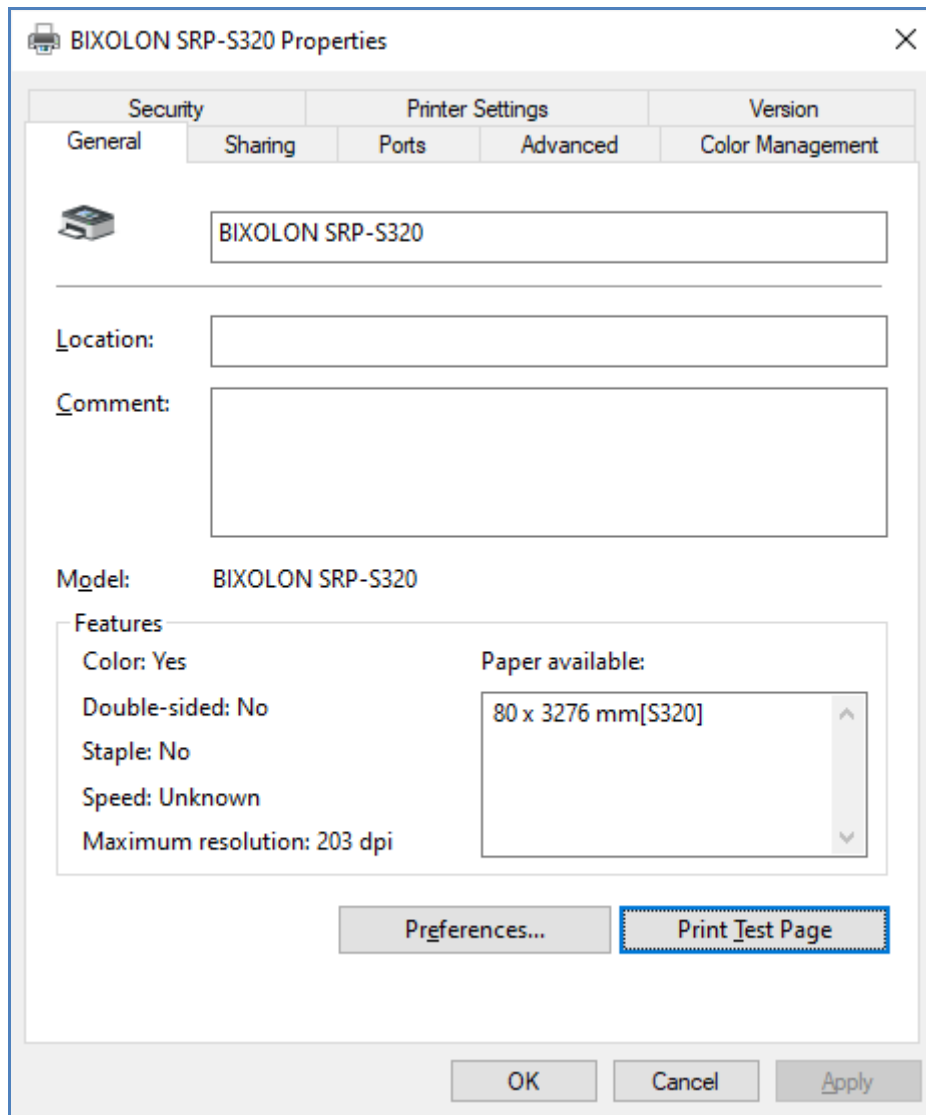

6. Factory Reset

6-1 Initializing WLAN Setting

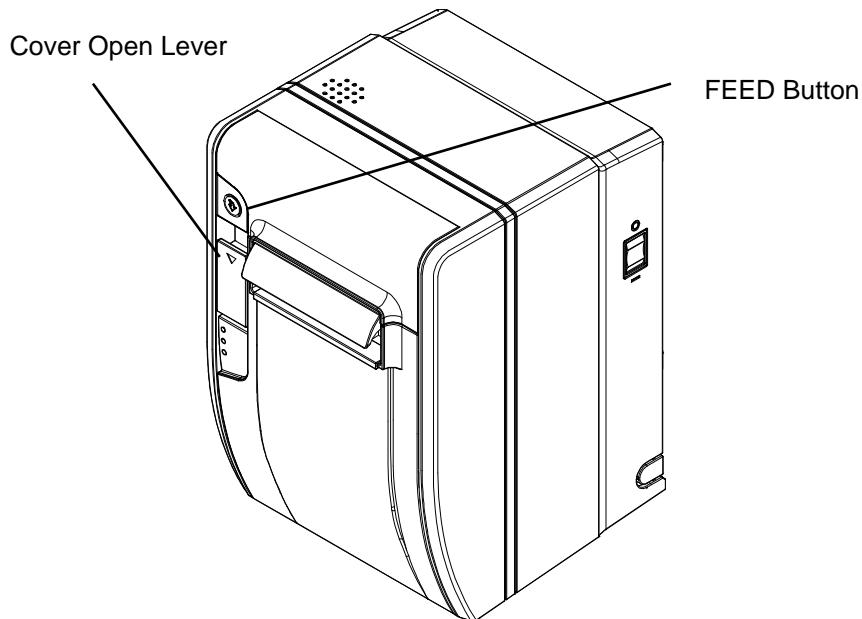

After the printer has finished booting, open the printer cover and press and hold the FEED Button for 5 seconds. This will cause the interface setting confirmation mode. Then add the paper, close the cover, and check that the following message is printed.

Checking Interface Setting

0: Exit
1: WLAN Information Print
2: WLAN Factory Reset and Reboot Printer
3 or more: None

Select Modes by Feed button control
as below.

Step 1. Short-press as many times as
The mode number to choose.

Step 2. Long-press over 1 second.

*e.g. To choose Mode 2, press Feed
Button 3 times(short-short-long)

If the above message is printed, select Mode 2, and you will see the following WLAN information. (To select Mode 2, press the Feed button twice quickly / once long.)

WLAN Factory Reset OK! Reboot Printer.
--

After the above message is printed, the printer will automatically reboot.

6-2 Factory Reset Values

LAN	Network	Inactivity time	0
		IP Assignment Method	Automatic(DHCP)
		Local Port	9100
WLAN	System	Printer Name	*Printer model
		Printer Port Num	9100
		User ID	admin
		User Password	password
	Enc / Auth	Encryption	None/Open
	Network	Network Mode	Soft AP mode
		SSID	PRINTER_{MAC address}
		Inactivity time	10
		IP Assignment Method	Manual (DHCP server)
		IP, Subnet, Gateway	IP : 192.168.1.1 Subnet : 255.255.255.0 Gateway : 192.168.1.2

7. Troubleshooting

<p>Check network setting (Refer to Configuration for checking/changing the printer settings)</p>	<ul style="list-style-type: none"> - IP Address Check the band of the IP Address. Check whether the bands of the printer and the AP (or wireless terminals) are the same. The first three digits of the four digit value of the IP address must be the same. - Subnet Mask Check whether the subnet mask of the printer matches the one in AP (or wireless terminal). - Port Check whether the port configured in the printer and the host (PC, PDA) are the same.
<p>PING Check</p>	<ul style="list-style-type: none"> - Checking IP collision When entering IP address manually without using DHCP, you must check whether the corresponding IP address is used by other equipment. The printer may not work normally when there is a collision in the IP address. When the printer is turned off, carry out the Ping Test to the printer IP. - Ping TEST <ol style="list-style-type: none"> 1) Turn off the printer. 2) Select “Run” from the Windows Start menu, and then enter “cmd”. 3) Enter “ARP -d” and delete ARP table. 4) Enter “ping {printer IP}”. 5) ARP -d, ping {IP address}

```

C:\WINDOWS\system32\cmd.exe
C:\Documents and Settings>arp -d

C:\Documents and Settings>ping 192.168.1.111

Pinging 192.168.1.111 with 32 bytes of data:

Request timed out.
Request timed out.
Request timed out.
Request timed out.

Ping statistics for 192.168.1.111:
    Packets: Sent = 4, Received = 0, Lost = 4 (100% loss),

C:\Documents and Settings>

```

When you see “Request timed out.” as shown below, it means that there is no collision. The corresponding IP can be used.

```

C:\WINDOWS\system32\cmd.exe
C:\Documents and Settings>ping 192.168.1.111

Pinging 192.168.1.111 with 32 bytes of data:

Reply from 192.168.1.111: bytes=32 time<1ms TTL=64
Reply from 192.168.1.111: bytes=32 time<1ms TTL=64
Reply from 192.168.1.111: bytes=32 time<1ms TTL=64
Reply from 192.168.1.111: bytes=32 time<1ms TTL=64

Ping statistics for 192.168.1.111:
    Packets: Sent = 4, Received = 4, Lost = 0 (0% loss),
    Approximate round trip times in milli-seconds:
        Minimum = 0ms, Maximum = 0ms, Average = 0ms

C:\Documents and Settings>_

```

On the other hand, if there is a reply as shown below, then the corresponding IP is used by another network terminal and it cannot be used for the printer IP.

Inactivity Time

If multiple host devices are used with one printer, “Inactivity Time” is Recommended. (Other host devices are restricted to use a printer if one host device keep connecting to a printer.) ex) 5sec

Copyright

© BIXOLON Co., Ltd. All rights reserved.

This user manual and all property of the product are protected under copyright law. It is strictly prohibited to copy, store, and transmit the whole or any part of the manual and any property of the product without the prior written approval of BIXOLON Co., Ltd. The information contained herein is designed only for use with this BIXOLON product. BIXOLON is not responsible for any direct or indirect damages, arising from or related to use of this information.

- The BIXOLON logo is the registered trademark of BIXOLON Co., Ltd.
- All other brand or product names are trademarks of their respective companies or organizations.

BIXOLON maintains ongoing efforts to enhance and upgrade the functions and quality of all our products.

In the following, product specifications and/or user manual content may be changed without prior notice.

Caution

Some semiconductor devices are easily damaged by static electricity. You should turn the printer “OFF”, before you connect or remove the cables on the rear side, in order to guard the printer against the static electricity. If the printer is damaged by the static electricity, you should turn the printer “OFF”.