



WLAN Connection Manual

SPP-R410

Mobile Printer
Rev. 1.00

■ Table of Contents

1. Manual Information.....3

2. Precautions3

3. How to Connect.....4

 3-1 Android Soft AP mode6

 3-2 iOS Soft AP mode.....7

 3-3 How to change infrastructure mode.....8

4. Factory Reset10

1. Manual Information

This WLAN manual provides information on the connection of wireless network with the mobile printer.

We at BIXOLON maintain ongoing efforts to enhance and upgrade the functions and quality of all our products. In following, product specifications and/or user manual content may be changed without prior notice.

2. Precautions

2-1 The printer has to be within 100m(Out door) from AP(Access point) to connect WLAN. Although 35m is able to communicate in door, WLAN could be affected by environment to be shorten.

The STATUS LED on the printer indicates the signal strength of the wireless LAN. When the green LED is on, the wireless LAN signal strength is good. When the green LED is blinking, the signal is weak. If the STATUS LED is off, it indicates that there is no signal from the AP, and the red LED is lit if the security option or key is incorrect.

2-2 The maximum separating distance may be shortened if transmission obstacles, such as cement walls, are present

2-3 If a device (such as a microwave oven, wireless LAN, etc.) that uses the same frequency is present, transmission may be interrupted. Separate the printer and Bluetooth-enabled device from such interrupting devices by a distance of at least 5m.

3. How to Connect

WLAN can be configured through the printer's WLAN interface. Likewise, WLAN can also be configured through the printer's Serial/USB interfaces.

(1) Connecting Printer

1) Serial / USB cable

Connect Serial/USB cable to Printer, PC device.

When Serial cable use, baudrate between Device and printer should be the same.

2) WLAN

Connect to the AP (Access Point) configured in Infrastructure mode in order to connect to the LAN/wireless network

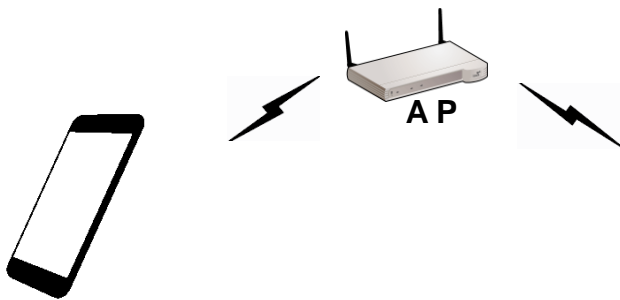

<Infrastructure mode>

In order to configure the network between the wireless host device and the printer, set the printer to Soft AP Mode.



<Soft AP mode>

(2) Checking Network Setting

Self-test

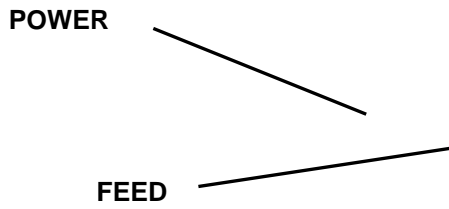

While the printer is turned off, turn on the printer while pressing the feed button. The printer setting values will then be printed.

3-1 Android Soft AP mode

1) Select “Wi-Fi”.

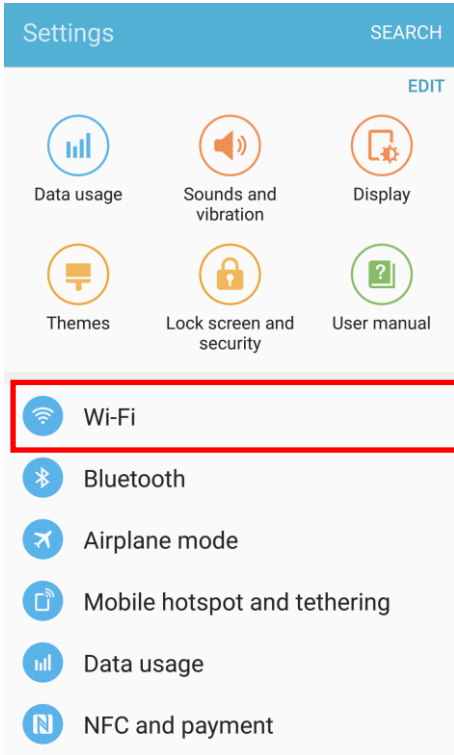

2) Select the printer to connect.

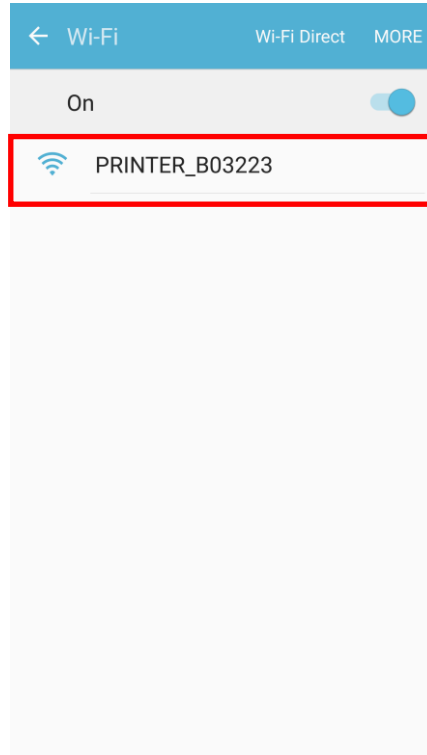

3) Select “CONNECT”.

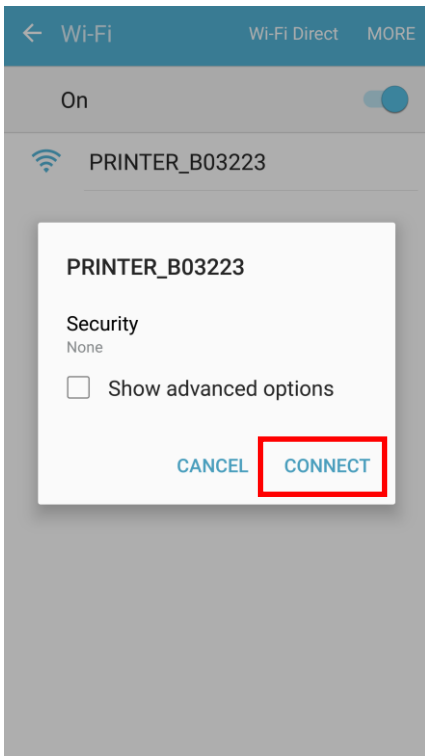

4) Wi-Fi communication is available.

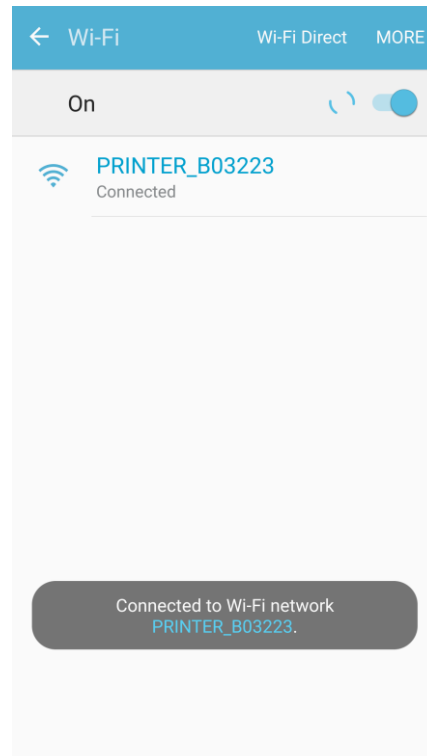

3-2 iOS Soft AP mode

1) Select "Wi-Fi".

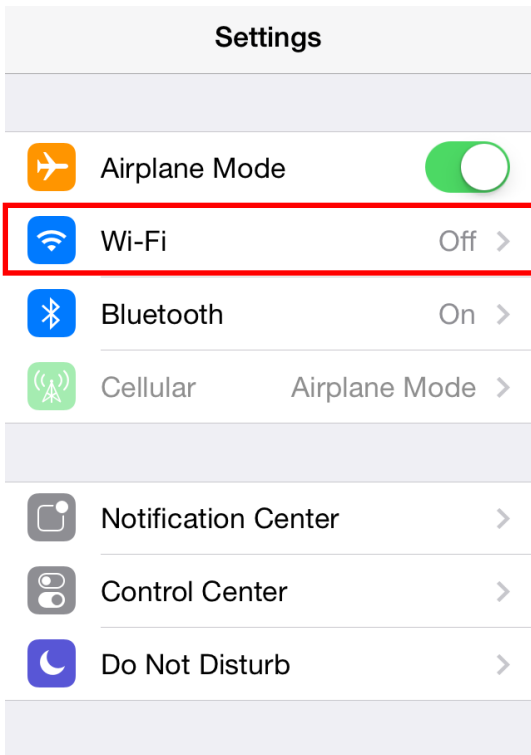

2) Wi-Fi ON and Select the printer to Connect.

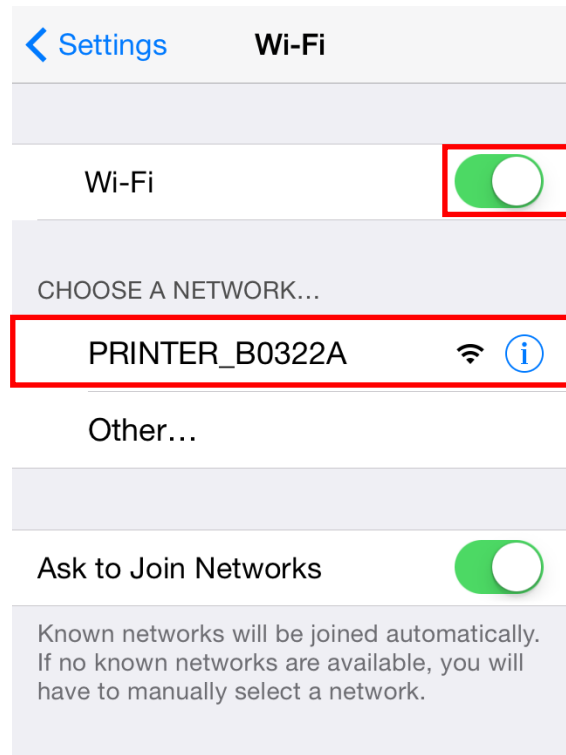

3) Wi-Fi communication is available

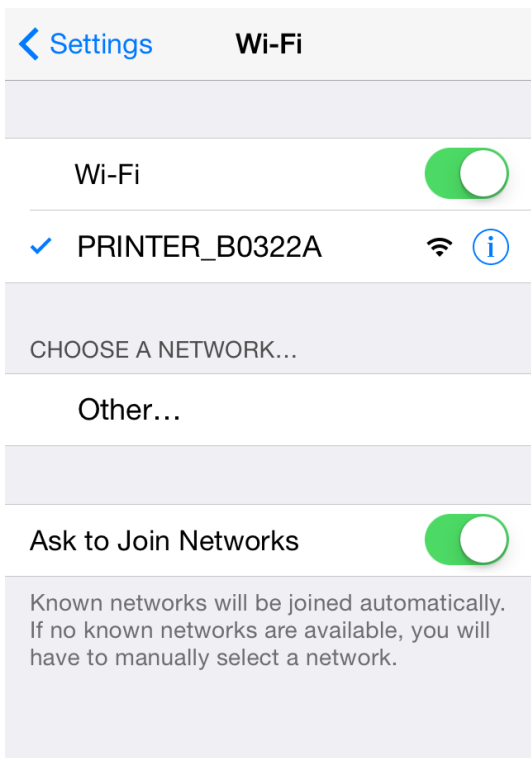

3-3 How to change infrastructure mode

- 1) Enter the IP address of the printer in the address bar, and the following login window will pop up. Enter the ID and Password set for the printer, and then click [LOG IN].
(Default User Name: admin, Password: password)

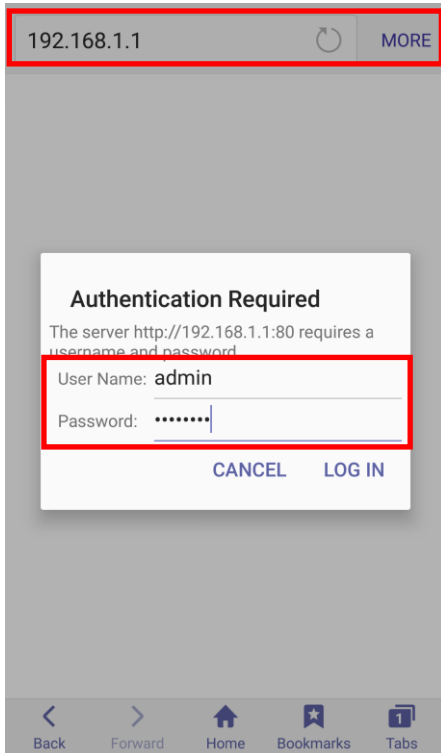

- 2) Select “Wireless” to change WLAN Connection Type.

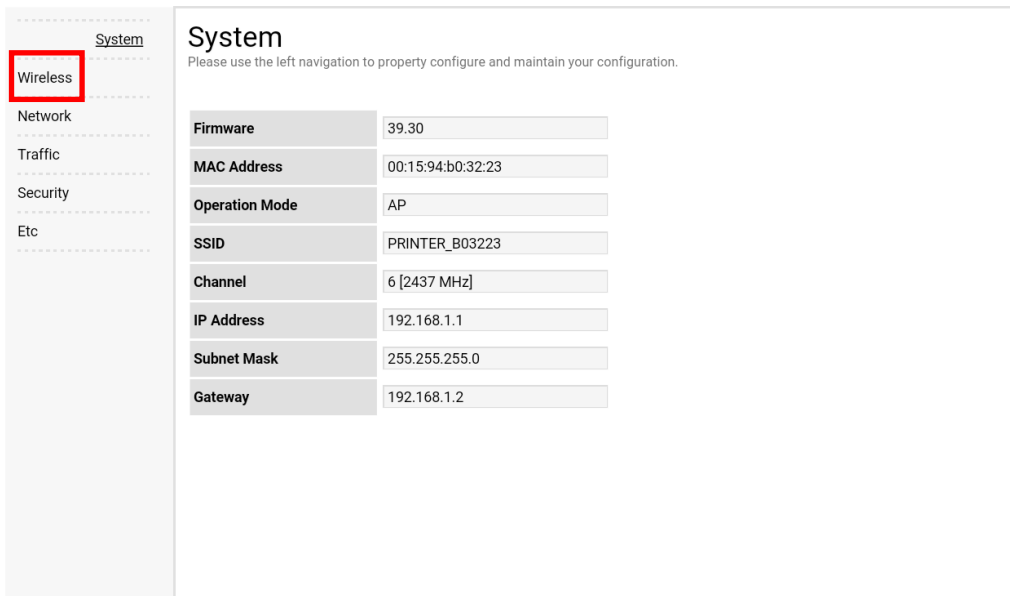

3) Select “Infrastructure”, and set SSID, WLAN Security Type.

The screenshot displays the 'Wireless' configuration page. On the left is a navigation menu with 'Wireless' selected. The main content area is titled 'Wireless' and includes a sub-header 'Please use the left navigation to property configure and maintain your configuration.' Below this, there are three input fields: 'Connection Type' with a dropdown menu set to 'Infrastructure', 'SSID' with a text box containing 'TEST_AP', and 'WLAN Security Type' with a dropdown menu set to 'Open'. To the right of these fields is an unchecked checkbox labeled 'Enterprise'. Below the fields, a warning message states: 'If you try connect, this connection will be disconnected.' At the bottom right, there is a 'Save' button.

4) Reboot the Printer.

4. Factory Reset

This function changes the WLAN settings of the printer to the initial factory settings.

Method

To set Factory reset mode, printer should be in Hexa Dump mode.

1) Hex dump mode

After turning off the power, open the cover.

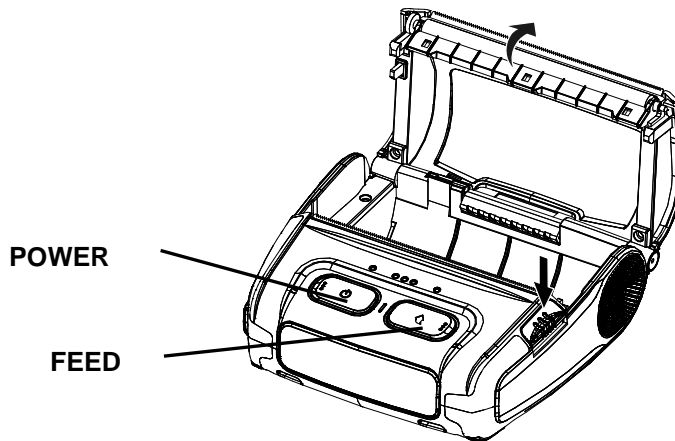

Turn on the printer while holding down the feed button like self test mode. Then close the cover to enter hexa dump mode. The below message is printed.

Hexadecimal Dump

To change WLAN setting values factory default
Press POWER button three times!!

To terminate hexadecimal dump
Press FEED button three times!!

Push the Power button 3times, WLAN setting will be reset as a factory default and below message is printed.

*** WLAN Factory Reset Completed! ***

*** Please Reboot Printer ***

< Online Hex Dump Completed >

After turning off the printer and on, WLAN setting will be factory default.

Factory Reset Values

System	Printer Name	* Printer model
	Printer Port Num	9100
	User ID	admin
	User Password	password
Enc / Auth	Encryption	None/Open
Network	Network Mode	Soft AP mode
	SSID	PRINTER_{MAC address}
	Inactivity time	10
	IP Assignment Method	Manual (DHCP server)
	IP, Subnet, Gateway	IP : 192.168.1.1 Subnet : 255.255.255.0 Gateway : 192.168.1.2

Specification

Feature	Implementation
Operation Mode	Infrastructure, Soft AP, Ad-hoc, Wi-Fi Direct
Wireless Standard	IEEE 802.11b/g/n, IEEE 802.11a/b/g/n
Range	Up to 100m free space (Outdoor)
Security	WEP64/128
	WPA1/2 – PSK
	WPA 1/2 – Enterprise (EAP-TLS, EAP-TTLS, PEAP, LEAP, EAP-FAST)
Management	NET Configuration tool, HTTP, Smart connection APP