

BIXOLON®

True Font Downloader Manual Label Printer

Rev. 1.00

**SLP-D220 / D220E
SLP-D223 / D223E**

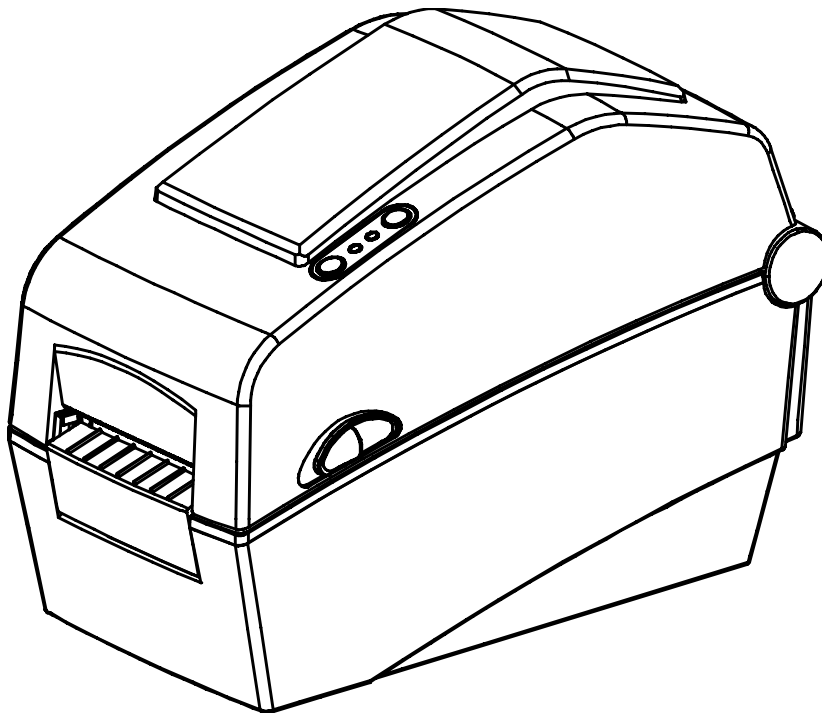

<http://www.bixolon.com>

■ Table of Contents

1. Manual Information.....	3
2. Operating System (OS) Environment.....	3
3. Set Font Download Utility	3
4. To download a new True type font to the printer	4

1. Manual Information

BIXOLON Font Downloader makes it possible to convert and download True Type ASCII fonts to the printer. The downloaded fonts can be used like the internal printer fonts by Text command. Please refer to the following explanation of each function for more information.

We at BIXOLON maintain ongoing efforts to enhance and upgrade the functions and quality of all our products. In following, product specifications and/or user manual content may be changed without prior notice.

2. Operating System (OS) Environment

The following operating systems are supported for usage.

Microsoft Windows 2000
Microsoft Windows XP (32bit/64bit)
Microsoft Windows 2003 Server (32bit/64bit)
Microsoft Windows Embedded For Point Of Service
Microsoft Windows VISTA (32bit/64bit)
Microsoft Windows 2008 Server (32bit/64bit)
Microsoft Windows 7 (32bit/64bit)

3. Set Font Download Utility

While the Windows driver installs, you can install the font download utility. After installation, there is a “BIXOLON Font Downloader” icon on the desktop.

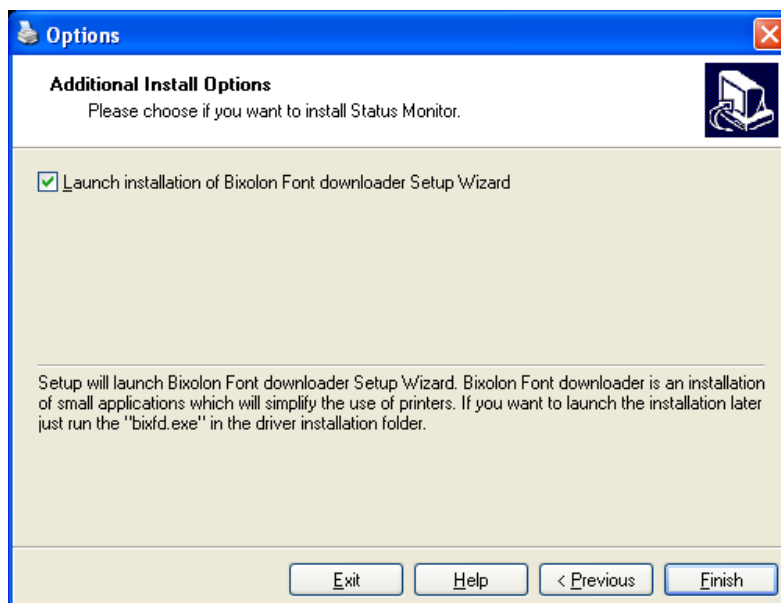

4. To download a new True type font to the printer

- 1) Double-click the “BIXOLON Font Downloader” icon.
- 2) Click on the “New” icon to make a new project file. This file contains the information about memory card type and font to be downloaded.

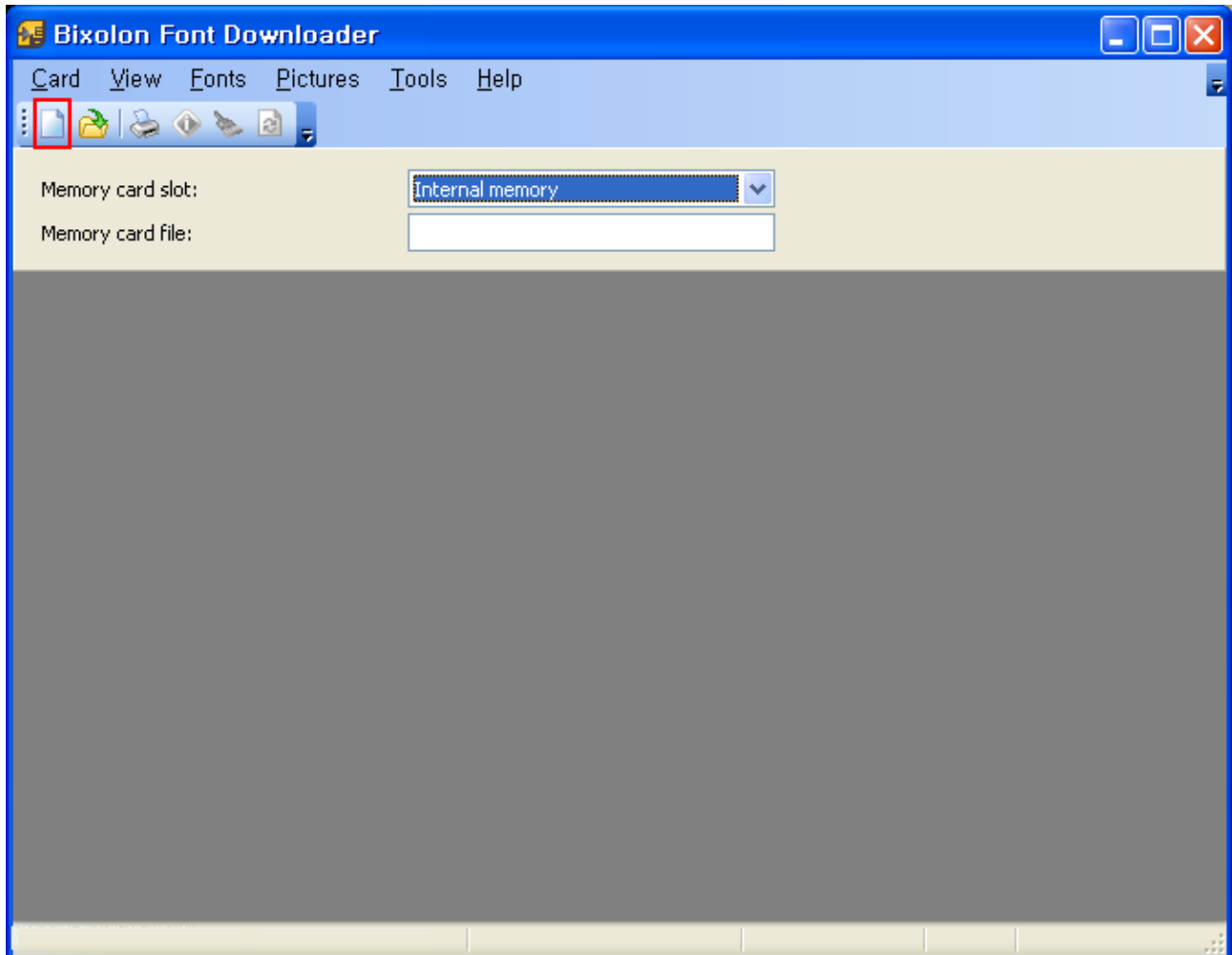

3) Press the **Save** button after selecting the memory card type and typing the file name.

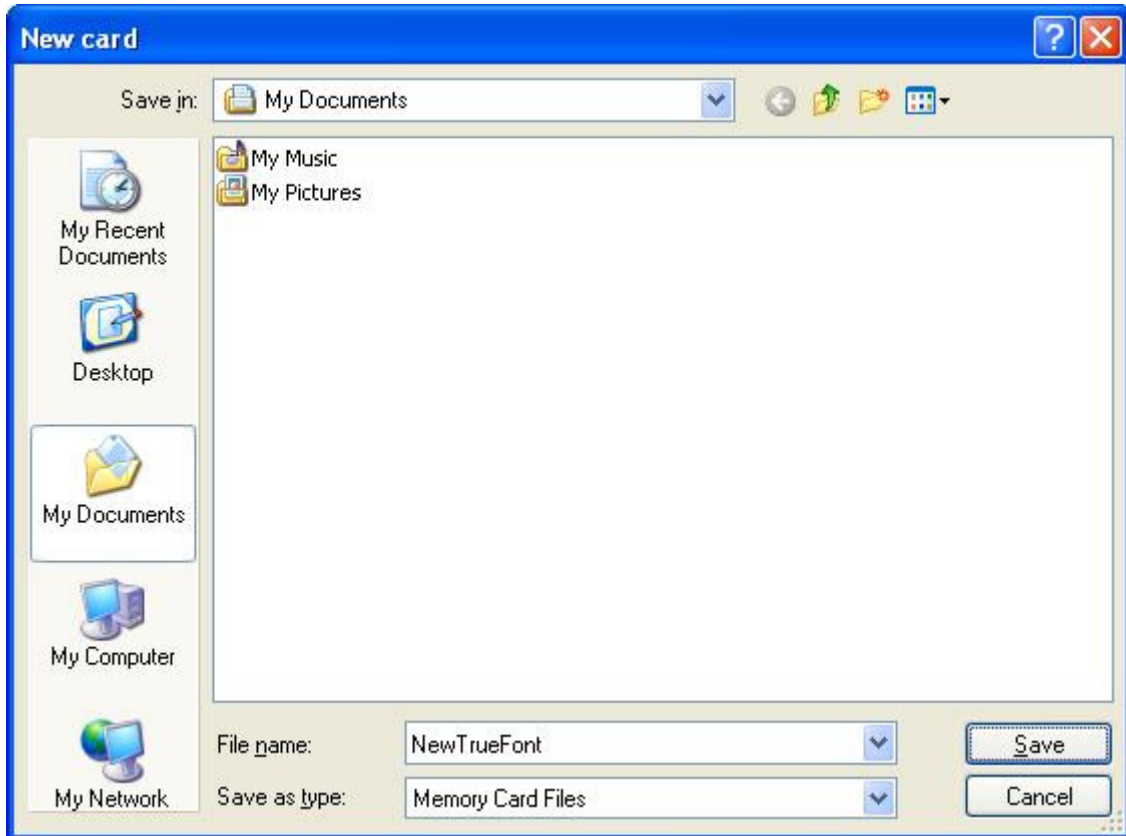

4) Input the description and press the **OK** button.

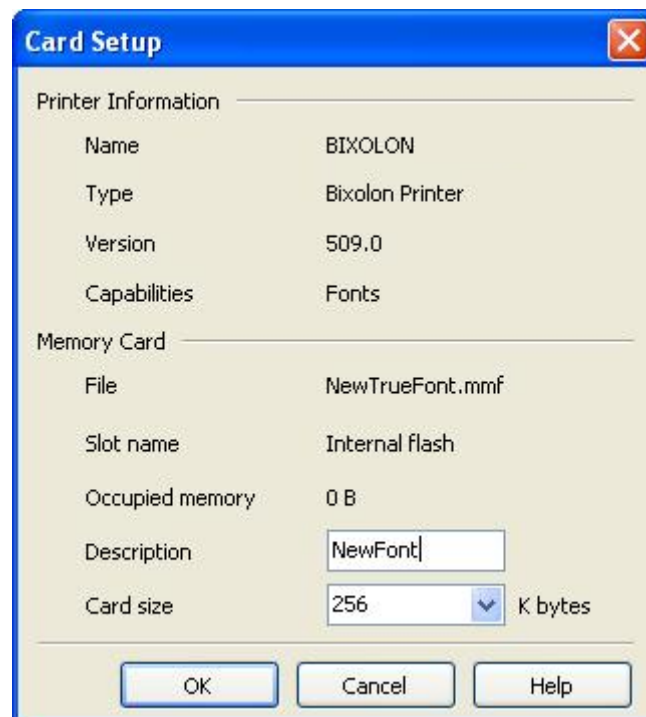

5) Click on the “Fonts-Add” to select font to be downloaded.

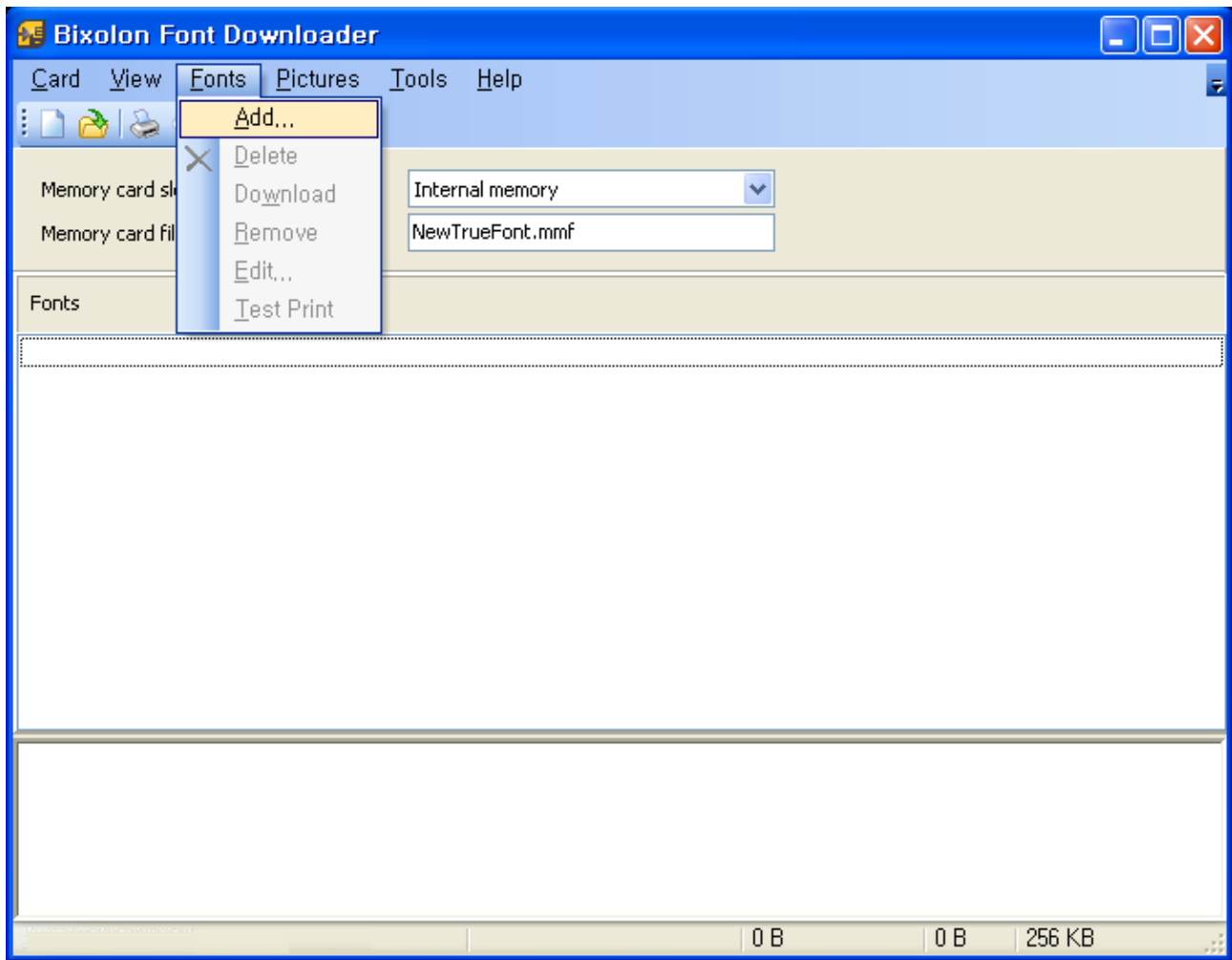

6) Specify the properties of the font and press the **OK** button.

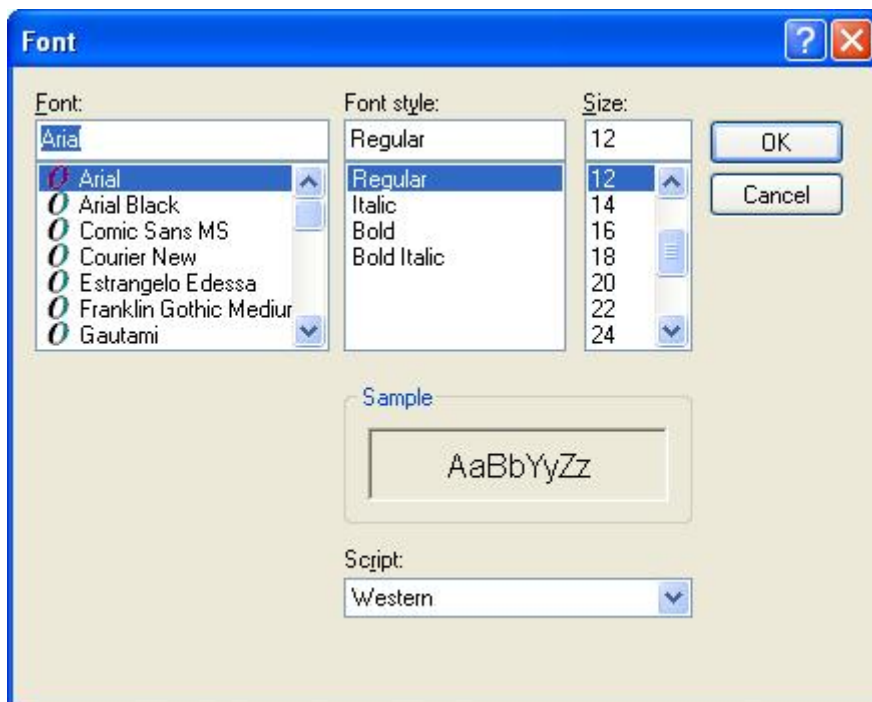

7) Now you can see the information of the font to be downloaded.

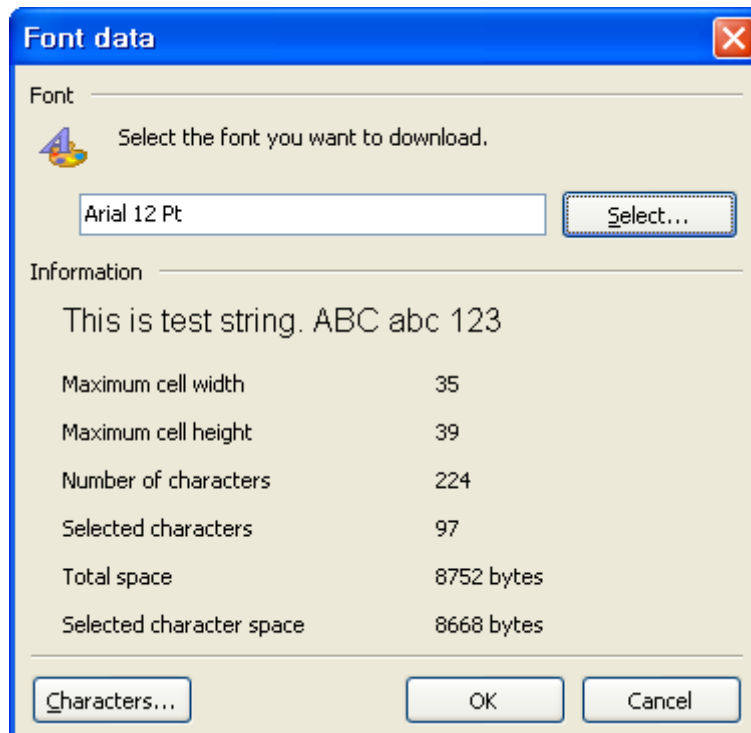

8) Press the **Characters** button to select characters to be downloaded.

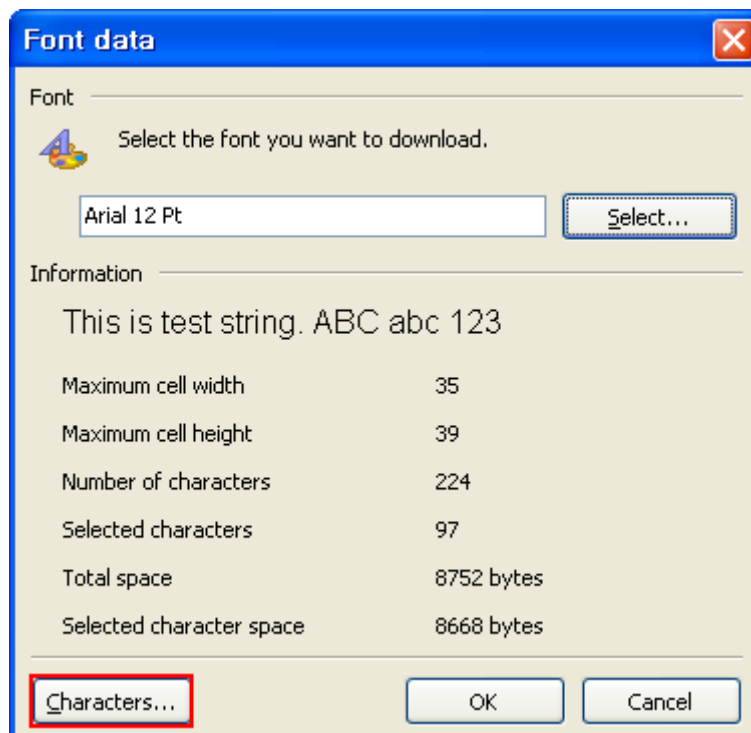

9) Press **OK** button after font selection.

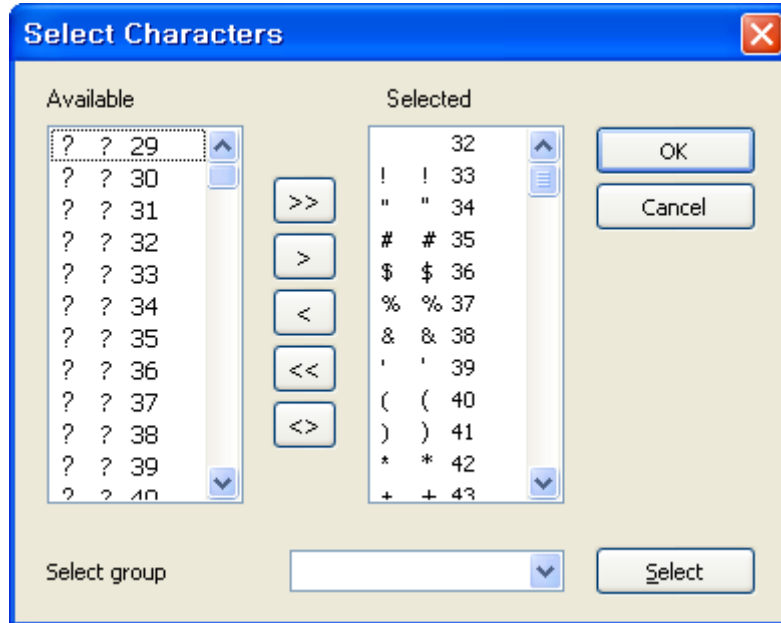

Available: Available font list

Selected: Selected font list to be downloaded

>>: Add all available fonts

>: Add selected fonts

<: Delete selected fonts from the selected list.

<<: Delete all fonts from the selected list.

<>: Exchange fonts with each other.

10) Press **OK** button

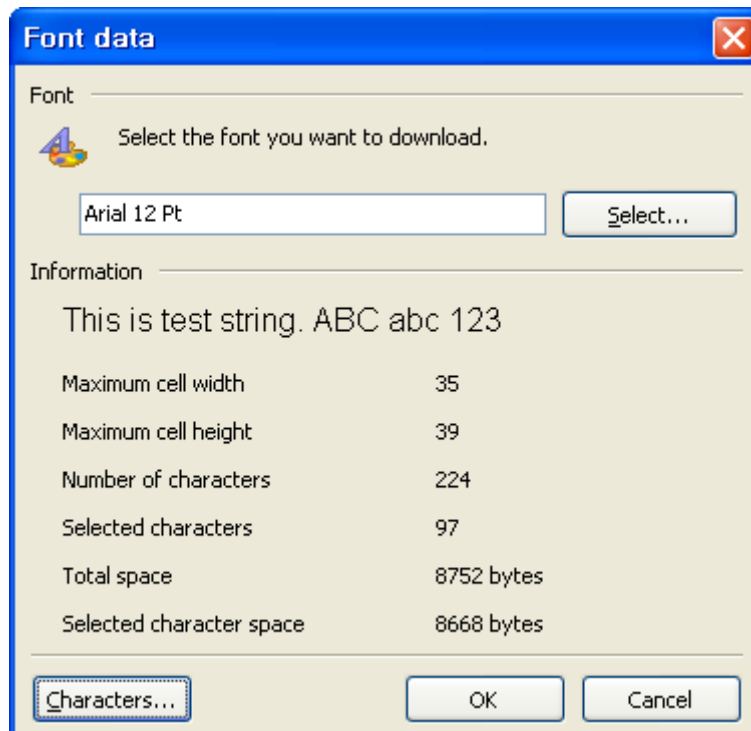

11) Press **Yes** button to start downloading fonts.

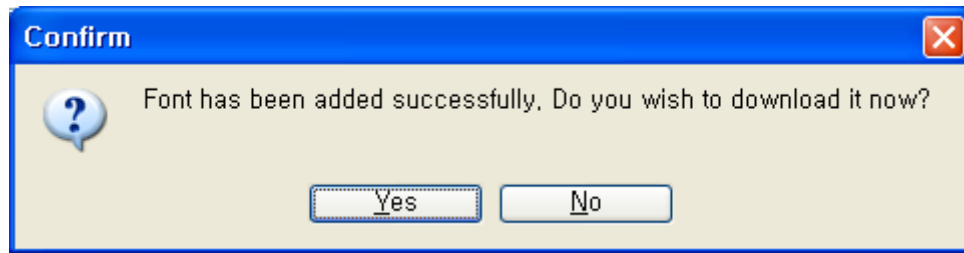

12) Downloaded font is shown on the Fonts list after download is completed.

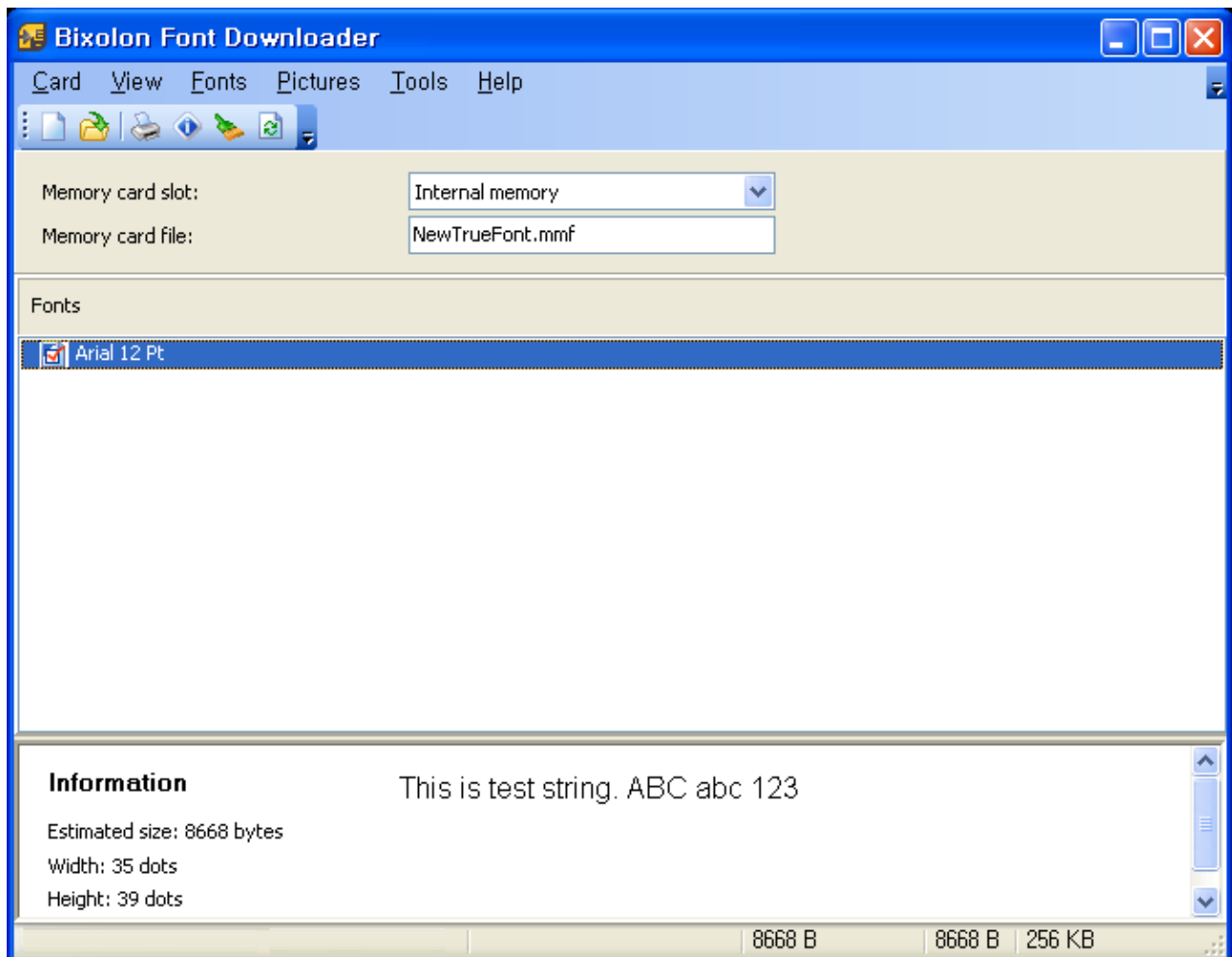

13) Card-Status printer menu tells the printer to print out the downloaded font list.

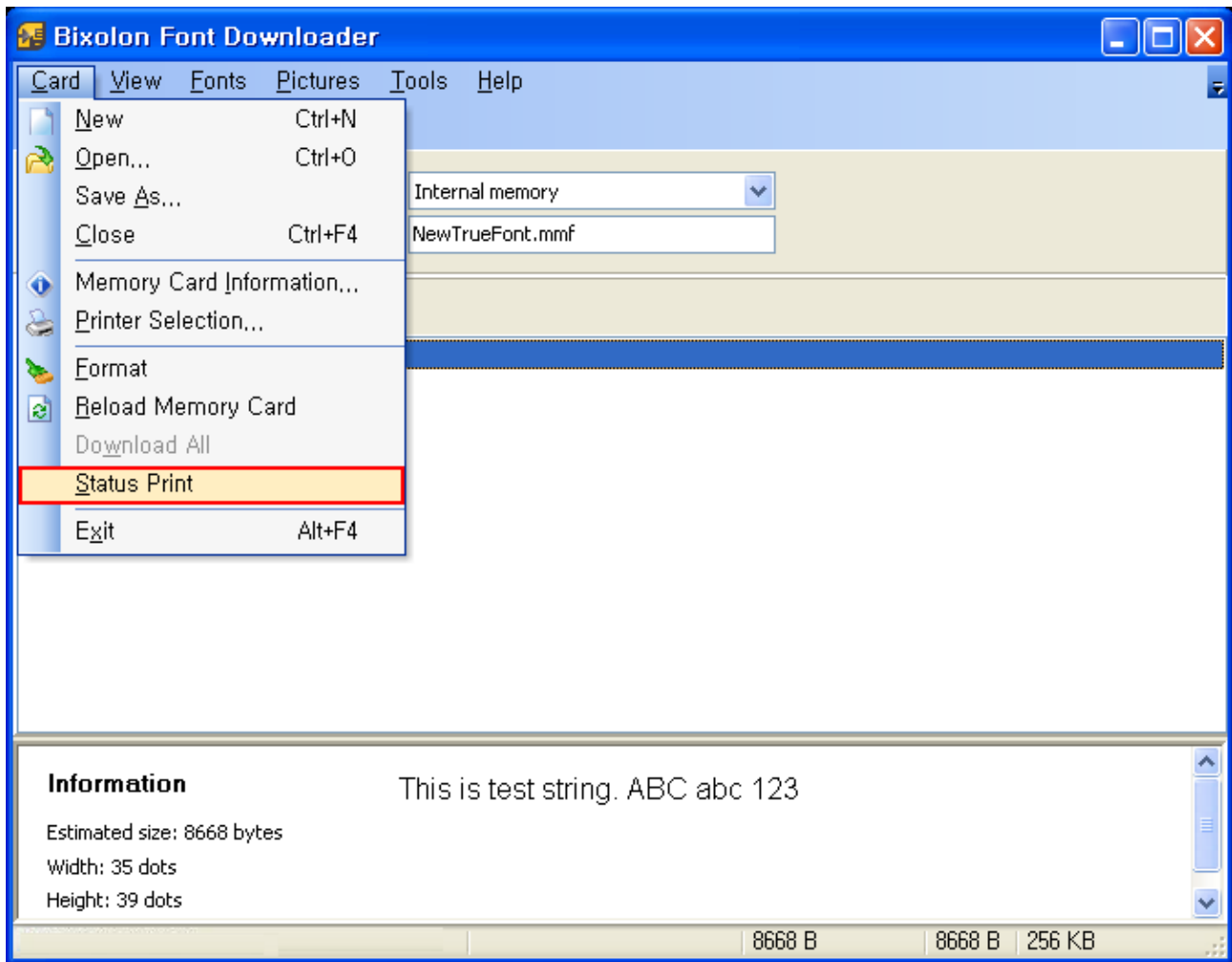

14) You can print the test string by pressing Fonts-Test Print menu.

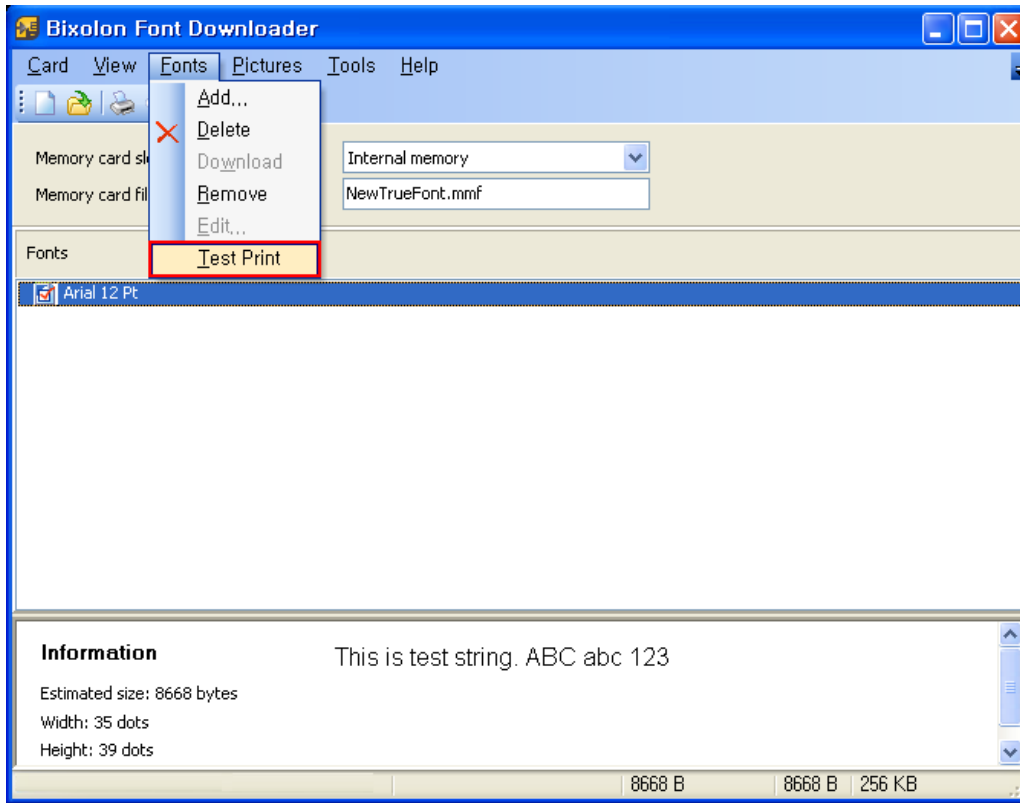

15) Downloaded fonts can be used like internal fonts with Text command. The font name to be referred in the Text command is as follows.

- If ID is 1, font name is A
- If ID is 2, font name is B

...

Ex) T10,10,A,1,1,0,N,N, 'This is a test'

