

1. Turn the Power Switch Off at the rear of the Printer and open the Cover.

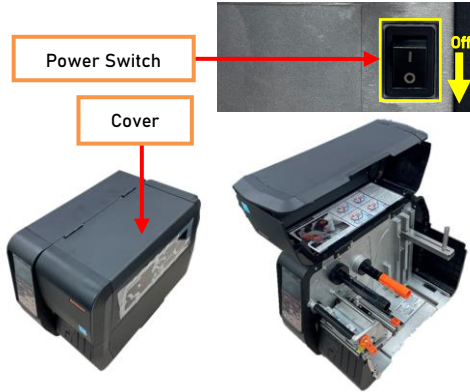

2. Release the Lever Lock.

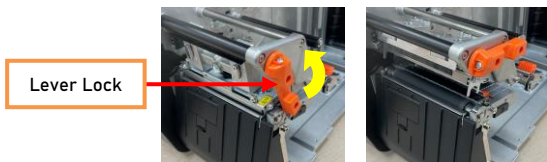

3. Disassemble the red mark on the TPH by pressing it down (as yellow arrow).
 ※ Take care to avoid injury by the parts around the area.

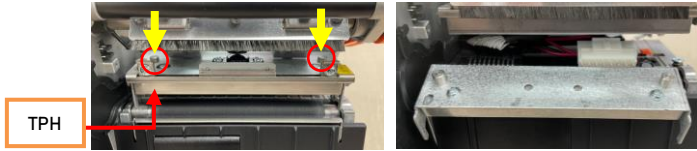

4. Separate the TPH Connector and Wire Connector on the back of the TPH.
 ※ Take care to avoid injury as the connectors are tightly attached.
 ※ Disassemble the white connector (as yellow square) by pressing the hook.

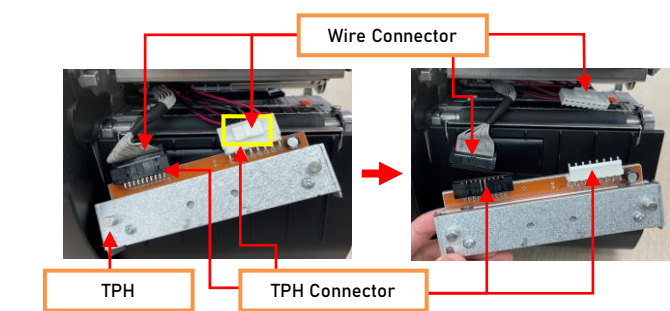

5. Assemble TPH Connector of the new TPH and Wire Connector in right direction.
 ※ Make sure that the connector is inserted all the way in.
 ※ Insert the white connector and fasten the hook.
 ※ If the connector is placed incorrectly, it may be damaged.
 ※ Avoid contact with the TPH Heating Line as it can damage the TPH.

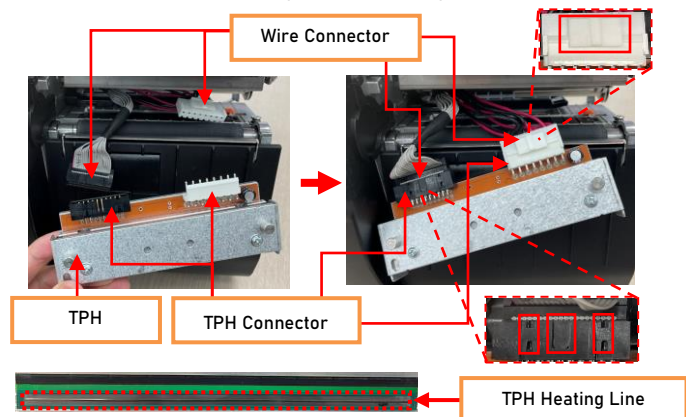

6-1. Arrange the wire on the back of the TPH (as yellow square).
 ※ Take care to avoid injury by the parts around the area.

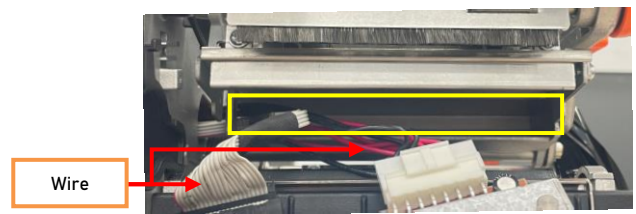

6-2. Assemble the 2 bosses on the back of the TPH to the hole (yellow square).
 ※ When assembling, be careful not to pinch the wire.

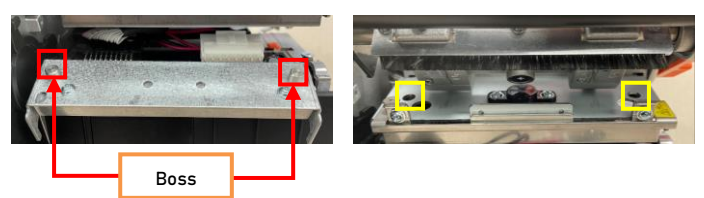

7. Install Media and Ribbon and lock Lever Lock.

※ Refer to the User Manual for how to install Media and Ribbon.

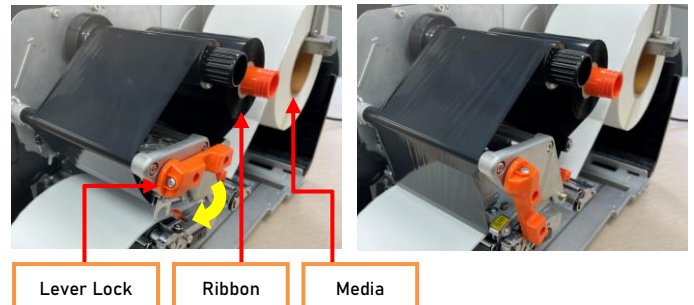

8. Close the Cover.

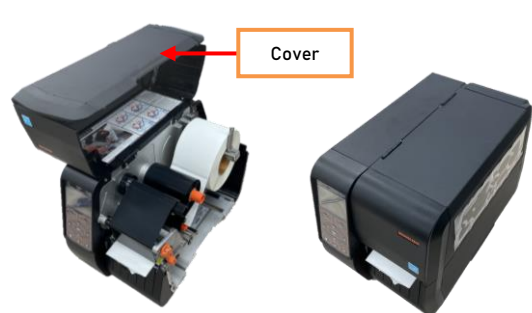

9. Turn on the Power Switch on the rear of the printer, perform a self-test, and check if there are any print quality problems.
 ※ Refer to the User Manual for how to proceed with the self-test.



1. Printer 후면의 Power Switch 를 Off 하고 Cover 를 열어주십시오

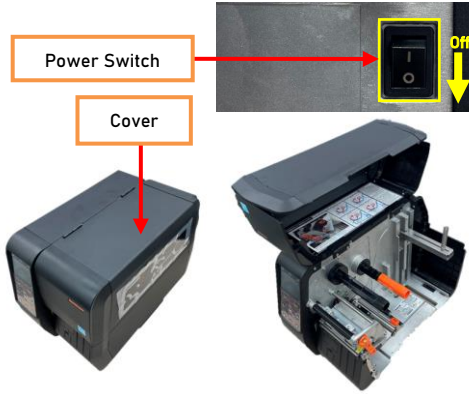

2. Lever Lock 을 열어 주십시오.

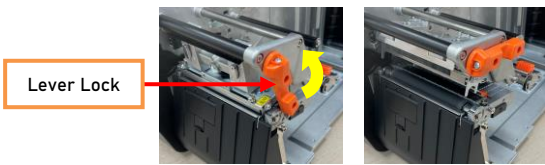

3. TPH 의 빨간색 표시 부를 아래 방향(노란색 화살표)으로 눌러 분리하십시오.
※ 작업 시 주변 부품에 의해 상처를 입지 않도록 주의하십시오.

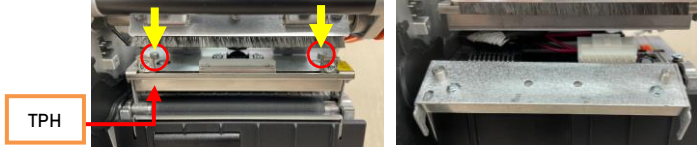

4. TPH 후면의 TPH Connector 와 Wire Connector 를 분리하십시오.
※ Connector 의 체결 강도가 높으니, 작업 시 신체에 손상을 입지 않도록 주의하십시오.
※ 하얀색 Connector(노란색 사각형)는 Hook 을 눌러서 분리하십시오.

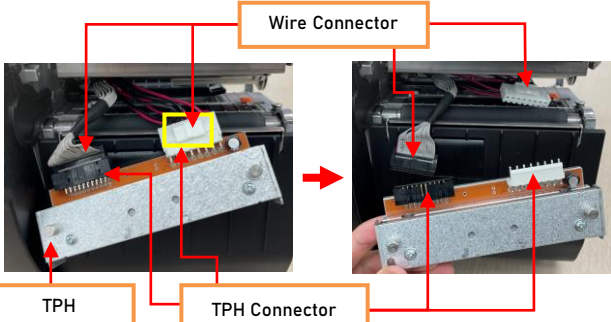

5. 준비된 신규 TPH 의 TPH Connector 와 Wire Connector 를 서로 방향에 맞게 조립하십시오.
※ Connector 가 삽입되지 않게 주의하십시오.
※ 하얀색 Connector 는 삽입하여 Hook 을 체결해 주십시오.
※ Connector 의 방향을 틀리게 삽입하면 Connector 가 파손될 수 있으니 주의하십시오.
※ TPH 의 Heating Line 을 접촉하면 TPH 가 손상될 수 있으니 작업 시 주의하십시오.

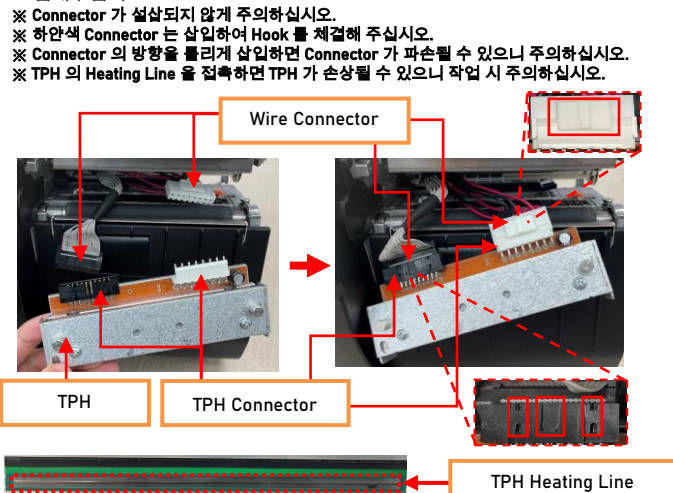

6-1. Wire 를 TPH 조립부 뒤쪽 공간(노란색 사각형)에 정형하십시오.
※ 작업 시 주변 부품에 의해 상처를 입지 않도록 주의하십시오.

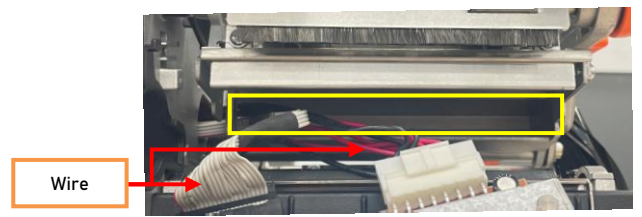

6-2. TPH 후면의 Boss 2 개소를 Hole(노란색 사각형)에 맞추어 조립하십시오.
※ 조립 시 Wire 가 끼이지 않도록 주의하십시오.

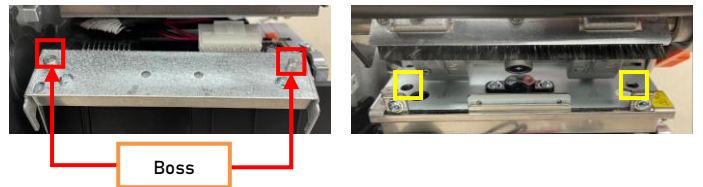

7. Media 와 Ribbon 을 장착하고 Lever Lock 을 닫아주십시오.
※ Media 및 Ribbon 장착 방법은 User Manual 을 참고해 주십시오.

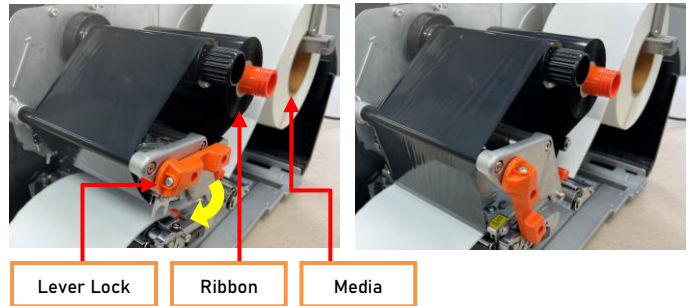

8. Cover 를 닫아주십시오.

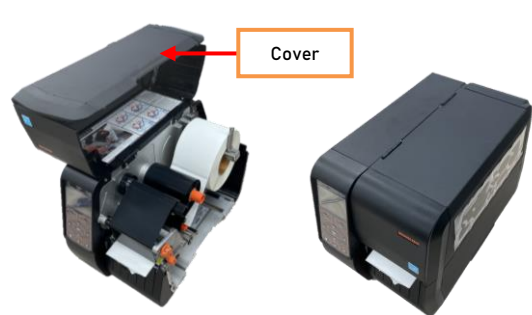

9. Printer 후면의 Power Switch 를 On 하고 Self-test 를 진행하여 인쇄 품질의 이상이 없는지 확인해 주십시오.
※ Self-test 진행 방법은 User Manual 을 참고해 주십시오.

